

# RADIO

AUGUST, 1946

MANUFACTURING  
AND  
BROADCASTING

The Journal for Radio & Electronic Engineers

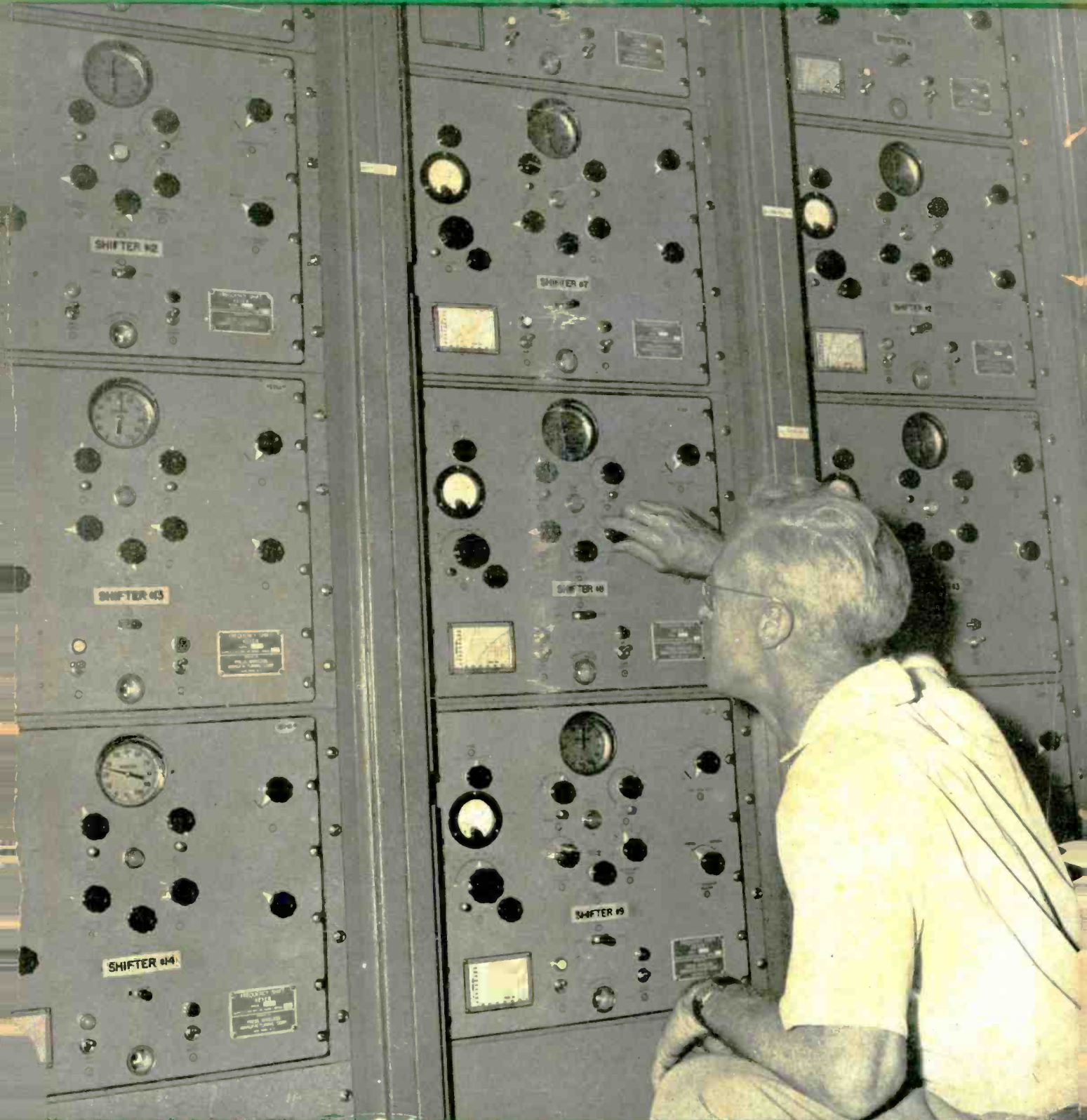

Design • Production • Operation



BETTER

# FM Reception

**AMPHENOL DIPOLE ANTENNAS**  
Amphenol Dipole Antennas and Dipole Antennas with Reflectors are engineered to provide excellent reception of FM even in zones of low signal strength.

The directional array virtually eliminates reflected signals, while building up required signal strength. The swivel feature on the mounting bracket and the mast head of the reflector types allows for tilting of the antenna plane to the optimum angle. An exclusive feature of all Amphenol FM Antennas is the Amphenol Twin-Lead low-loss transmission line from antenna to receiver.

**TWIN-LEAD TRANSMISSION LINE**  
A recent Amphenol innovation—a perfect parallel-line lead-in wire extruded with polyethylene dielectric. This low-loss transmission line is highly efficient, inexpensive and completely moisture-proof, and remains flexible at temperatures well below zero. Twin-Lead is manufactured in three impedances that cover requirements for all Broadcast, FM and Television reception.

300 OHM provides best impedance match for FM and Television.  
150 OHM is for experimental work and other special applications.  
75 OHM is best suited to match a  $\frac{1}{2}$  wave element and should be used where receiver input impedance is 75 ohms.

**AMPHENOL**

**AMERICAN PHENOLIC CORPORATION**  
CHICAGO 50, ILLINOIS  
In Canada • Amphenol Limited • Toronto



# RADIO

Published by RADIO MAGAZINES, INC.

John H. Potts.....Editor  
Sanford R. Cowan.....Publisher

AUGUST, 1946

Vol. 30, No. 8

## CONTENTS

### COVER

A portion of the frequency shifter rack in operation at the Hicksville, Long Is. Communication Division of Press Wireless, Inc.

### ARTICLES

Traveling Wave Tubes, by *Martin A. Barton* ..... 11  
*Theoretical considerations concerning the new 4000-mc broad-band are discussed.*

Frequency Shift Keying Techniques, by *Chris Buff* ..... 14  
*Development of circuits for frequency shift keying and fac simile transmission occupies increasing attention.*

Notes on Field Laboratory Design, by *A. C. Matthews* ..... 18  
*Receiver design engineers do a better job when provided with testing installations which simulate residential conditions.*

Radio Design Worksheet No. 51—Graphical Analysis of the Cathode-Coupled Amplifier: Symmetrical T and H Attenuators ..... 20

Recent Radio Inventions: Thermionic Tube Circuit; Telegraph Signaling System ..... 22

### MISCELLANEOUS

Transients ..... 3

TECHNICALS ..... 6

Magnetic Deflection ..... 6

X-Ray in Tube Work ..... 8

New Products ..... 23

Advertising Index ..... 32

John H. Potts.....President-Editor  
Sanford R. Cowan.....Sec'y-Treas.—Adv. Mgr.  
Robert G. Middleton.....Associate Editor  
Evelyn A. Eisenberg.....Assistant Editor  
Harry N. Reizes.....Adv. Sales  
David Saltman .....Adv. Prod. Mgr.  
Miriam Birnbaum.....Circ. Manager

#### MID-WEST OFFICE

Harold J. Sugarman, Manager  
82 West Washington St., Chicago 2, Ill.  
ANDover 1395

#### PACIFIC COAST REPRESENTATIVE

JAMES C. GALLOWAY  
816 W. 5th St., Los Angeles 13, Calif.

FOREIGN SUBSCRIPTION REPRESENTATIVES  
Radio Society of Great Britain, New Ruskin House, Little Russell St., London, W.C. 1, England. Harris & Floyd, 297-299 Swanston St., Melbourne, C. I. Victoria, Australia

RADIO Magazine (title registered U. S. Pat. Off.) is published monthly at Boston Post Road, Orange, Connecticut, by Radio Magazines, Inc. Executive and Editorial Offices at 342 Madison Avenue, New York 17, N. Y. Subscription rates—United States, U. S. Possessions & Canada, \$3.00 for 1 year, \$5.00 for 2 years; elsewhere \$4.00 per year. Single copies 35c. Printed in U.S.A. All rights reserved, entire contents Copyright 1946 by Radio Magazines, Inc. Entered as Second Class Matter May 10, 1945 at the Post Office at Orange, Conn. under the Act of March 3, 1879.

# Highlights in THE 1946

## Jensen LINE

★ *Hypex*  
PROJECTORS

★ **COAXIAL**  
SPEAKERS

★ *Speech  
Master*  
REPRODUCERS

★ *Bass Reflex*  
REPRODUCERS



★ **HYPEX Projectors** better than ever—more efficient. They have the famous Hypex "flare formula"—not exponential—developed by Jensen acoustical research. Driver units employ the Jensen "Annular" diaphragm, clamped at periphery and center—another exclusive feature!

★ **COAXIAL Speakers.** Now four improved 15" and 12" designs for high-fidelity, extended-range reproduction. High-frequency Control provides instant fidelity adjustment to suit program quality and listener preference. Available in complete Reproducers.

★ **SPEECH MASTER Reproducers.** Designed especially for crisp highly-effective speech reproduction. Desk-, panel-, wall-mounting types in power ratings for low-level and high-level applications.

★ **BASS REFLEX<sup>®</sup> Reproducers.** A complete line of reproducers with speaker installed, or enclosures only, in fine furniture or utility styles—all with the smoothly extended low-frequency range for which Jensen Bass Reflex is justly famous.

\*Trade Mark Registered

*These are only a few of the many distinguished products in the complete Jensen line. Write for catalogs and data sheets for further information.*

JENSEN MANUFACTURING COMPANY

6615 S. LARAMIE AVE., CHICAGO 38, ILLINOIS

In Canada—Copper Wire Products, Ltd. 11 King Street West, Toronto

 **Jensen**  
SPEAKERS  
WITH  
**ALNICO 5**

*Specialists in Design and Manufacture of Acoustic Equipment*

# Transients

---

## TRAVELING WAVE TUBE

★ The recent announcement of Bell Labs of the development of the traveling wave tube is a brilliant example of the ability of modern scientists to devise new means of getting results when the need becomes sufficiently great. This is the only tube which can be used in an amplifier to provide high gain over a broad band of frequencies of the order of 4000 mc. The traveling wave tube is destined to become just as important in microwave communication as the magnetron or klystron—perhaps even more so.

We feel fortunate in being able to present in this issue the first technical discussion of this new type of tube to appear in any magazine.

## RADIO PRODUCTION

★ Production of radio receivers during June exceeded 1,000,000 sets of all types, according to an RMA report on production statistics. This is about the same as the highest average pre-war monthly rate, but is still far below capacity. Furthermore, production of FM sets amounted to only 17,273, principally because of the cabinet shortage which limits production of all types of console receivers.

Principal cause of restricted production is shortage of labor and materials. Shipment of large quantities of sets has been delayed because of tube shortages, particularly rectifiers.

## PRICE CONTROL

★ The OPA situation in the radio industry becomes daily more and more befuddled. While price control is supposed to be removed only when the supply equals the demand, we learn that the first receivers to be decontrolled are household television sets, of which but 200 have been produced this year. Announced purpose of this action is to stimulate production of such receivers. It surely needs it.

But if price decontrol will stimulate production, why not do the same for vitally needed components, such as speakers, tubes, copper wire, gang condensers, con-

sole cabinets, which are not available in sufficient quantities to enable full scale production at the present time? Personally we don't think decontrol would help much—some components are now selling below ceiling, and even finished table model, radio-phono combinations are now being advertised in New York well below ceiling price. But the much-desired big sets are still scarce.

We believe in price control, under present-day conditions, as applied to rents and commodities, but it failed to benefit either the radio industry or the prospective purchaser of radios.

## GOVERNMENT SURPLUS

★ One of the most feared bogeys of reconversion which has failed of its expected results is the dumping of surplus radio and electronic equipment by the government. Many had advocated scrapping, rather than resale, of such merchandise to avoid injuring the market.

However, not much had been disposed of up until the end of February, 1946. According to the War Assets Administration, total sales up to that time amounted to but \$17 million dollars, although \$300 million dollars worth (at reported original cost) was available for disposal. Surplus on hand amounted to \$115 million in components and lab. assemblies, \$60 million in equipment, \$48 million in tubes, balance in miscellaneous equipment. Although an undetermined portion of this has already been sold since February, there is still a very large inventory of surplus for sale.

It would be valuable to know in detail just what is likely to be offered in the near future. There are still shortages in tubes of certain types, and if any such are now surplus, immediate sale would greatly help the radio industry.

Estimated future acquisitions of surplus electronic equipment and apparatus range from \$1 billion to \$2 billion, but the WAA announces that most is expected to be commercially unsalable and will probably be scrapped.

—J. H. P.



# Why

## this team sets the

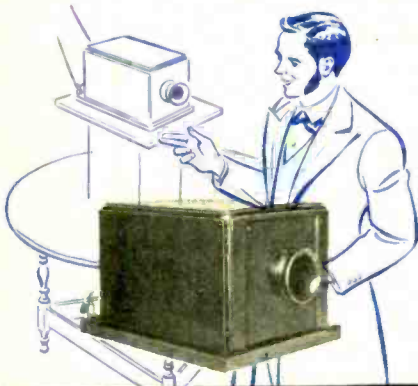

1877: Grand-daddy of all microphones was Alexander Graham Bell's box telephone, into which Thomas A. Watson shouted and sang in the first intercity demonstrations of the infant art of telephony.



1920: Telephone scientists developed the first successful commercial mike—the double carbon button air-damped type. Used first in public address systems, it later became the early symbol of broadcasting.

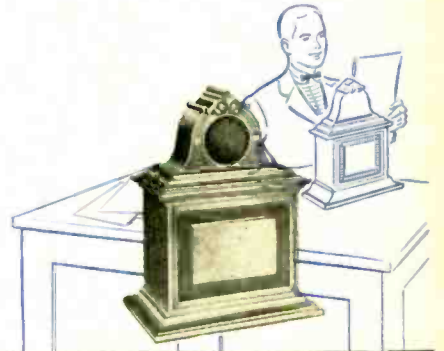

1921: The condenser microphone, designed by Bell Laboratories for sound measurement in 1916, entered the public address and broadcasting field. It provided a wide frequency range and reduced distortion.

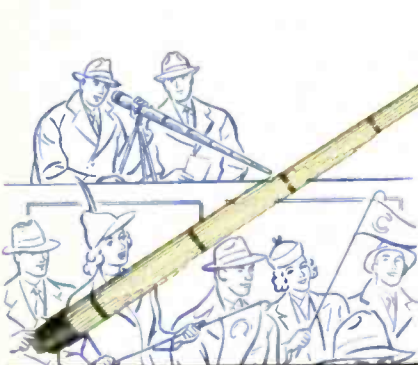

1937: The Western Electric "Machine Gun" mike does for sound pick-up what the telephoto lens does for photography. Sharply directional, this microphone makes sound "close-ups" at unusually long range.



1938: Cardioid directional microphone, with ribbon and dynamic elements, was the first mike ever to combine 3 pick-up patterns in one instrument. The later 639B, with 6 patterns, is also one of the finest all-purpose mikes ever made.



# pace in Microphone Development



1931: Bell Telephone Laboratories developed the Western Electric moving coil or dynamic microphone. The first of its kind, it was rugged, noiseless, compact, and needed no polarizing energy. Many are still in use.



1935: The first non-directional mike — the famous Western Electric 8-Ball, designed by Bell Laboratories. Small, spherical, it provided top quality single mike pick-up of speech or music from every direction.



1936: Directional with slide-on baffle, non-directional without it, the Western Electric Salt Shaker gave highest quality pick-up at new low cost. Widely used in studios and remotes as well as in high quality sound distribution.



1946: No larger in diameter than a quarter, the 640 Double-A condenser mike (shown with associated amplifier) is ideal for single mike high fidelity pick-ups. It was originally designed as a laboratory test instrument.

What is a microphone? Fundamentally it's a device which converts sound into electrical energy—just what Bell's original telephone did for the first time each year back in the seventies.

Today's Western Electric mikes—the Salt Shaker, Cardioid and 640 Double-A—are a far cry from the first crude, close-talking telephone transmitter. But they're its direct descendants.

Year after year, Bell Telephone scientists—through continuing research—have developed finer and finer telephones and microphones.

Year after year, Western Electric has manufactured these instruments, building quality into each one.

Together these teammates have been responsible for almost every important advance in microphone development.

Whether you want a single mike, a complete broadcasting station, or radio telephone equipment for use on land, at sea or in the air, here's the point to remember:

If Bell Telephone Laboratories designed it and Western Electric made it, you can be sure there's nothing finer.



## BELL TELEPHONE LABORATORIES

World's largest organization devoted exclusively to research and development in all phases of electrical communications.

# Western Electric

Manufacturing unit of the Bell System and the nation's largest producer of communications equipment.



# TECHNICANA

## MAGNETIC DEFLECTION

★ Essential design factors involved in obtaining linear deflection with magnetic deflection yokes are discussed in an article by W. T. Cocking in *Wireless World* for July, 1946. The author limits his investigation to tetrode and pentode amplifiers driving the yoke through a transformer, as shown in *Fig. 1*. He points out that with one circuit, more than one mode of operation is possible.

In the analysis, it is assumed that the tube is driven by a sawtooth voltage of good waveform, implying that the sawtooth voltage rises linearly in time during the scan time, falling back in arbitrary fashion (later discussed in the article) during the flyback time. These periods are 84  $\mu$ s and 14.8  $\mu$ s, respectively, in the British system.

To obtain a linear current waveform in the deflecting coils, mathematical considerations on the basis of the Fourier analysis indicate that the twentieth harmonic of the fundamental should be passed, accompanied with a minimum of frequency and phase distortion. Such considerations lead to choice of special core materials. On the other hand, practical experience shows that silicon-steel cores are satisfactory, and that few harmonics above the third need to be passed. The discrepancy is due to lack of sharp corners in the practical waveform, and, as the author later points out, the corrective influence of the tube characteristic upon an exponential waveform of current through the yoke.

It is preferable, Mr. Cocking says, to consider the problem from the standpoint of *RLC* response to suitably-timed impulse excitation, using the equivalent

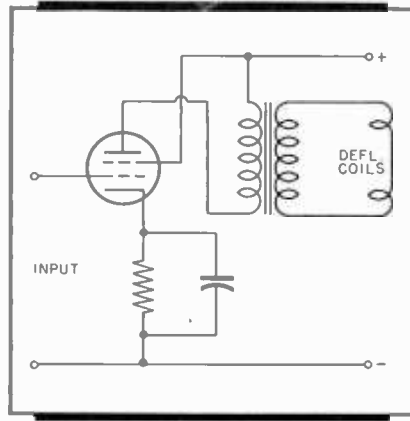

Figure 1

circuit of *Fig. 2*. Here the amplifier tube is represented by  $-g_m e_g$  and  $R_p$ , and the core losses by  $R_2$  (which includes any shunt damping losses present),  $L_p$ ,  $L_s$ ,  $r_p$ ,  $r_s$ ,  $C_p$ , and  $C_s$  are the transformer constants, and  $R_L$  and  $L_L$  the deflection coil constants. The constant-current equivalent circuit is derived as shown in *Fig. 3*. In this circuit,  $R_1$  is the equivalent resistance of  $R_p$  and  $R_2$  in parallel. The transformer ratio is  $n$ , and  $k$  is the coupling coefficient,  $M/\sqrt{L_p L_s}$ . The author then defines the problem as follows; during a period of time  $t_s$ , it is required that the current through  $L_L$  shall change linearly with time.

The magnitude of the change will depend on deflection coil design, tube used, and supply potential. With  $L_L = 3$  mh, a typical current change is 600 ma. In the equations which follow,  $I$  = change of current, and instantaneous current is denoted by  $i_L$ . The time interval under consideration is from  $t = 0$  to  $t = t_s$ .

It is then observed that if the scan is to be linear,  $i = I/t_s + I_1$ , where  $I_1$  is the d.c. through  $L_L$ , which thus constitutes a basic design equation. To simplify the analysis, it is assumed throughout, that the current taken by  $C_s$  is very small with respect to  $i$ , and that  $r_s$  is negligible. On this basis, the simplified equivalent circuit of *Fig. 4* is derived.

If the deflection coil current is linear, the voltage  $E$  across  $L$  and  $R$  is

$$E = (IRt/t_s + LI/t_s)k/n$$

The total current required by the circuit during the scan is

$$i = \frac{I}{n} \left[ \frac{L/R_1}{t_s} + \frac{t}{t_s} \left( 1 + \frac{R}{R_1} + \frac{L}{L_p} + \frac{I^2}{2I L_p/R} \right) \right]$$

It is usually inconvenient to have the tube supply the last term of the current equation, and last values are therefore selected to make this term negligible. Although the coil current is then exponential, curvature of the tube characteristics is such as to maintain practical linearity. The required correction is less than  $2\%$  if  $L_p \ll 4.2n^2(R_1 + r_s)$ , where  $L_p$  is expressed in mh.

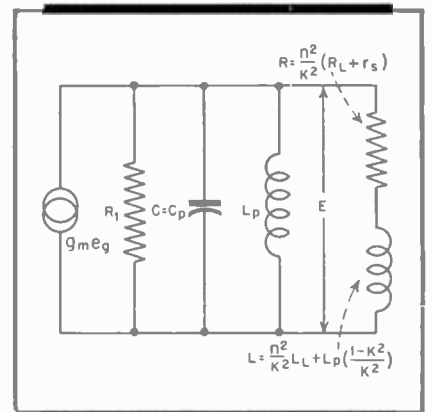

Figure 4

If  $R$  (*Fig. 4*) is quite small, only a small value of  $L_p$  is needed to achieve linearity, and efficiency is low.  $L_p$  should be designed to be at least ten times  $L$ . The voltage developed across the transformer primary has a maximum value of  $(IR + LI/t_s)k/n$  when  $t = t_s$ , and re-

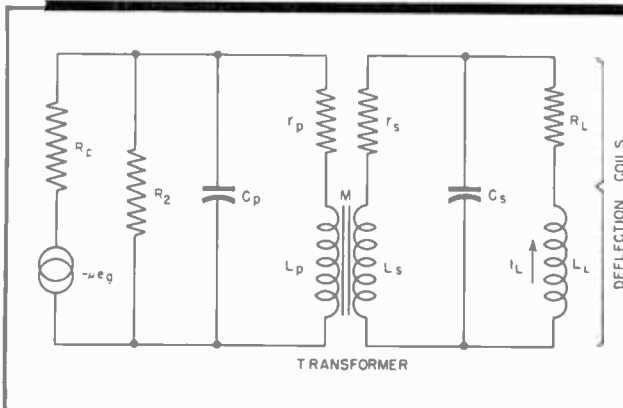

Figure 2

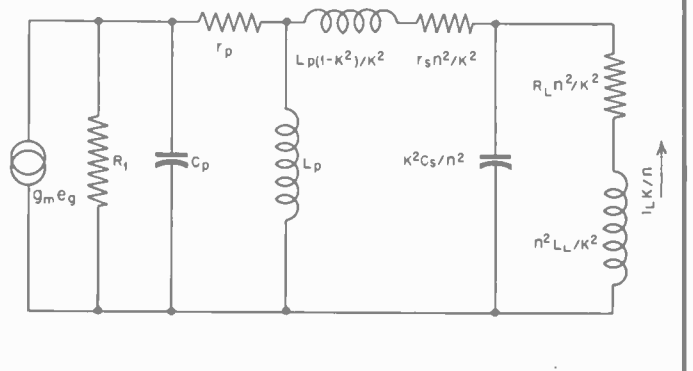

Figure 3





**Eimac**  
TUBES

THE COUNTERSIGN OF  
DEPENDABILITY IN ANY  
ELECTRONIC EQUIPMENT

## HIGH POWER LOW PLATE VOLTAGE

The famous Eimac 75T is now available in both high and low amplification factor types (75TH-75TL). These exceptionally flexible triodes provide a high power output at low plate voltage, and require a minimum of driving power. These Eimac 75T's are suitable for use as oscillators, amplifiers, or modulators. For example: a pair of 75TL's in a class-C amplifier can easily be operated at 500 watts input with only 1500 volts on the plate. The required grid driving power for the two tubes would be only 12 watts. In a class-B modulator, two 75TL's operated within 1500 plate volts will deliver 280 watts of audio power, sufficient to more than 100% modulate the above mentioned RF amplifier.

The Eimac 152T has twice the power handling capacity and twice the transconductance of the 75T, but *less* than twice the already low grid-plate capacity. At 1500 plate volts, 500 watts input can be run to a single 152TL, or a full kilowatt can be run to a pair of 152TL's in a class-C amplifier. For class-B audio, a pair of 152TL's will deliver 560 watts with 1500 plate volts. Eimac 152T's are also available in high and low amplification factor versions. Literature giving full technical information on these triodes available now. Write today, or contact your nearest Eimac representative.

Follow the leaders to

**Eimac**  
REG. U. S. PAT. OFF.  
TUBES

EITEL-McCULLOUGH, INC., 1245-G San Mateo Ave., San Bruno, Calif.  
Plant located at San Bruno, California

Export Agents: Irazar and Hansen, 301 Clay Street, San Francisco 11, California, U.S.A.

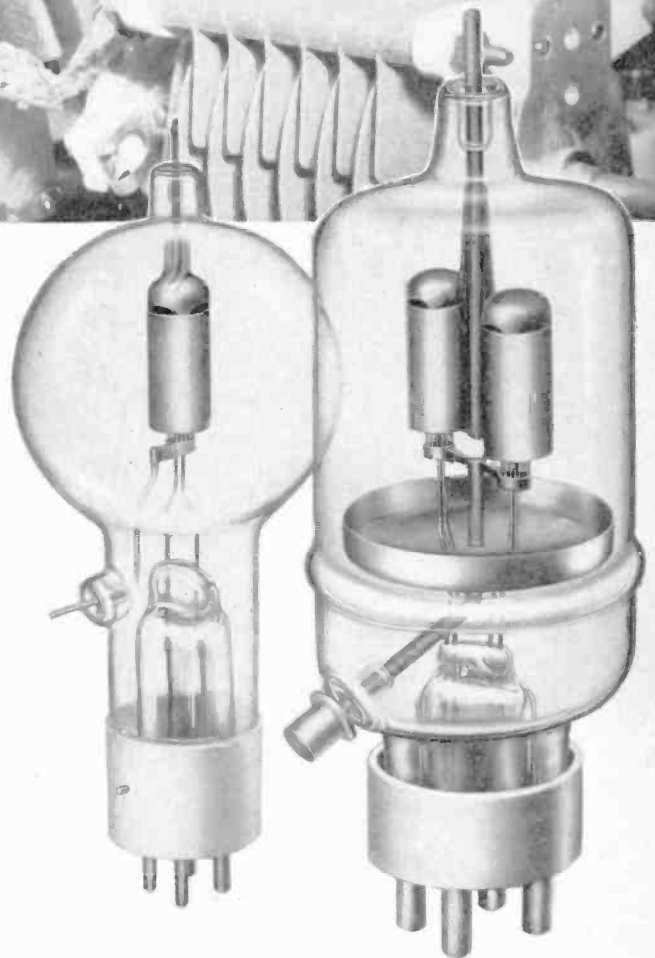

EIMAC 75T  
POWER TRIODE

EIMAC 152T  
POWER TRIODE

### CALL IN AN EIMAC REPRESENTATIVE FOR INFORMATION

ROYAL J. HIGGINS (W9AO), 600 S. Michigan Ave., Room 818, Chicago 5, Illinois. Phone: Harrison 5948.

VERNER O. JENSEN, Verner O. Jensen Company, 2615 Second Ave., Seattle 1, Washington. Phone: Elliott 6871

M. B. PATTERSON (W5CI) Patterson & Company, 1124 Irwin Keasler Bldg., Dallas 1, Texas. Phone: Central 5764.

ADOLPH SCHWARTZ (W2CN), 220 Broadway, Room 2210, New York 7, New York. Phone: Courtland 7-0011.

HERB. B. BECKER (W6GC), 1406 So. Grand Ave., Los Angeles 15 California. Phone: REhmond 6191.

TIM COAKLEY (W1KKP1), 11 Beacon St., Boston 8, Massachusetts. Phone: Capital 0450.

RONALD C. BOWEN, 183a So. Humboldt St., Denver 10, Colorado. Phone: Spruce 9488.

JAMES MULLAR ASSOCIATES, J. E. Jayner, Jr. (W4TO) 1000 Peachtree St., N. E., Atlanta, Georgia.

**FCC PREDICTS HUGE COMMUNICATIONS EXPANSION WITHIN NEXT FEW YEARS**

400 new AM stations  
 2950 FM stations  
 5000 more radio-equipped planes  
 1800 aviation ground stations  
 radio equipped autos, trains, railroads  
 facsimile, ship-to-shore, multi-purpose micro-wave relay link systems and many other new services will be readied and operative within the next few years . . .

—from BROADCASTING, 6/14



— R. C. A. Photo

**You Can Qualify for One of These New, Good-Paying Jobs**

**CREI Technical Training NOW Will Enable You to Gain the Ability to Choose Your Job Tomorrow—Right in Your Own Home Town**

Never before have men like you had the chance to step into brand new jobs in brand new fields. FM, Television, Facsimile and other electronic communications systems for both government and industry will require thousands of highly trained, expert radio communications engineers and technicians.

NOW is the time to take the time to prepare yourself for these important career jobs. CREI home study training can show you the way by providing you with the "tools" with which to build a firm foundation of ability based on a planned program of modern technical training.

This is real, honest-to-goodness practical radio engineering training that leads to better jobs and more rapid promotions . . . the type of training for which many thousands of professional radiomen have enrolled during the past 19 years.

Mail coupon for free booklet today. (CREI training for veterans is available under the "G.I." Bill.)

**Capitol Radio Engineering Institute**

E. H. RIETZKE, President

Dept. RA-8, 16th and Park Road, N.W., Washington 10, D. C.

Branch Offices:

New York (7): 170 Broadway Chicago (2): 30 N. LaSalle St. San Francisco (2): 760 Market St.



If you have had professional or amateur radio experience and want to make more money, let us prove to you we have the training you need to qualify for a better radio job. To help us intelligently answer your inquiry—PLEASE STATE BRIEFLY YOUR BACKGROUND OF EXPERIENCE, EDUCATION AND PRESENT POSITION.

**INDUCTANCE**

Funny how many men are like an electrical conductor that becomes electrified when near a charged body. Expose them to the right training, thinking and study and they turn out "first rate." Men who are looking ahead, place themselves in positions where they are continuously preparing for a better job, tomorrow.

*E. H. Rietzke*  
 President of CREI

**TECHNICANA**

[from page 6]

duces the supply voltage by this amount. Should the reduction be excessive, distortion is again introduced and the picture will be squeezed up on the right-hand side.

Mr. Cocking further considers the fly-back period and conditions of oscillation. Diode damping is discussed, with less than critical damping recommended. Used in conjunction with negative feedback, resistance damping is preferred.

The article concludes with a dozen design equations of central interest to the worker in this field.

**X-RAY IN TUBE WORK**

★ A good theoretical and practical discussion of radiographic techniques as applied to tube development work and production sampling is presented by R. M. Mitchell in an article "Notes on Radiography in the Wireless Industry," in the *Marconi Review* for Jan.-March, 1946. The properties and methods of generating X-rays are examined, as well as the complicated problems of making satisfactory radiographs.

Development of miniature stabilivolt tubes is cited by the author as a useful application of radiography. Electrical tests had shown considerable variation in the performance of specimens from the production line, and this was revealed by radiographs to result from variations in spacing of auxiliary striker pin and striker. The auxiliary striker pin is a fine wire pointing inward from the tubular-shaped cathode, while the striker is a vertical wire between cathode and plate.

Another fault was discovered while studying these gap variations: a filament is fired during manufacture, and if it sags it may cause a short. Radiated heat was also observed to bend the striker, and these points were quickly established with the aid of radiographs.

The writer points out that routine photographing of miniature vacuum tubes, while a valuable technique in development work, proves too costly in routine production. However, for large transmitting tubes, radiographic inspection is frequently justified. For example, a high-power tube which was imperfect in test for an unexplained reason, showed on the X-ray plate to have had its supposedly straight filament distorted into curves, either during manufacture or possibly from spurious v-h-f oscillation during test.

Mr. Mitchell also points out the value of radiography in detecting flaws in molded plastic products with inserts, such as plug and socket contacts, where much time is saved and non-destructive testing realized.

RA-8

Capitol Radio Engineering Institute  
 16th and Park Road, N. W., Washington 10, D. C.

GENTLEMEN: Please send me your free booklet, "Your Opportunity in the New World of Electronics", together with full details of your home study training. I am attaching a brief resume of my experience, education and present position.

Name .....

Street .....

City..... Zone..... State.....

Occupation .....

I am entitled to training under the G.I. Bill.



## Guess who didn't know an Adlake Relay was on the job!

AN Adlake Mercury Relay can always be depended on, whether it's in burglar alarms or any of hundreds of other uses.

Whatever your relay needs may be, only Adlake Plunger-type Mercury Relays offer you all these *plus* advantages:

Hermetically sealed; dust, dirt, moisture or oxidation cannot interfere with operation . . . mercury-to-mercury contact; chatterless, silent, impervious to burning, pitting or sticking . . . absolutely safe . . . no maintenance required.

Write today for free, illustrated Adlake Relay folder! No obligation, naturally.

*Is there a job here YOU want done?*

Adlake Plunger-type Mercury Relays are *proved best* in these and other applications:

Radio transmission • Standard telephone circuits • Precision control instruments • Animated displays • Railroad and traffic controls • Burglar alarms • Heating and ventilating controls • Refrigeration controls • X-ray control • Dry cleaning equipment • Remote and automatic controls • Production line time controls • Photo-electric apparatus • Motor reversing switches • Sign flashers • Electric time controls • Navigation buoy flasher light controls • Surgical lighting controls • Cable electrolysis prevention • Signals and indicators • Electric call systems • Across-the-line motor start switches • Power circuits • Air-conditioning controls • Mill and factory service • Voltage regulators.



# THE ADAMS & WESTLAKE COMPANY

ESTABLISHED IN 1857

ELKHART, INDIANA

NEW YORK • CHICAGO

Manufacturers of Adlake Hermetically Sealed Mercury Relays for Timing, Load and Control Circuits

RADIO

★ AUGUST, 1946



# RACON IS THE BEST IN SOUNDEQUIPMENT

Leading Soundmen everywhere specify RACON Horns, Speakers and Driving Units when quoting on potential sound installation sales or rental contracts because RACONS deliver maximum output and response for size of driving unit used. There's a RACON sound reproducer for every conceivable purpose. Each affords more dependable and efficient service and they are competitively priced.

SEND FOR CATALOG  
OF COMPLETE LINE

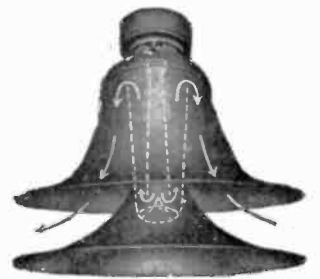

**RADIAL HORN SPEAKER;** a 3 1/2' re-entrant type horn. Projects sound over 360° area. Storm-proof. Made of RACON Acoustic Material to prevent resonant effects.



**PAGING HORN;** extremely efficient 2' trumpet speaker for use where highly concentrated sound is required to override high noise levels. Uses P.M. unit.

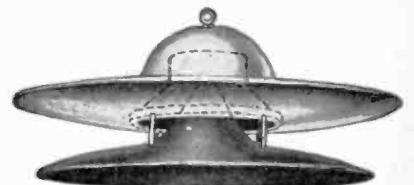

**RADIAL CONE SPEAKER;** projects sound over 360° area. Cone speaker driven. Will blend with ceiling architecture. RACON Acoustic Material prevents resonant effects.

**RACON ELECTRIC CO., INC. 52 EAST 19th ST. NEW YORK, N. Y.**

# TRAVELING WAVE TUBES

MARTIN A. BARTON

**We believe this to be the first published technical discussion of an epoch-making development in microwave transmission. The traveling wave tube is the first device which enables design of an amplifier to provide high gain over a broad band at an operating frequency of the order of 4000 megacycles**

THE RECENT RELEASE by the Bell Telephone Laboratories of information concerning the performance of a sample traveling wave tube has caused much interest throughout the industry. The possibility of building a vacuum tube amplifier in the region around 4000 mc without the use of any sharply resonant structures is of utmost importance. Such a device opens the way to the use of extremely broad-band transmissions over highly directional beams and would allow a radio relay network to be constructed which could handle high fidelity television programs as well as an extremely large number of simultaneous telephone conversations or other equivalent services. Since traveling wave tubes can be built to handle any frequency within 400 mc of a nominal 4000 mc operating frequency, present limitations on the band width which can be effectively used depend more on the wave guide transmission systems used to couple to the tube than upon the operation of the tube itself.

## Use in Relay Service

As between the magnetron and the klystron, which are the other two types of vacuum tubes currently available for use at true microwave frequencies, the traveling wave tube comes closer to resembling the klystron although its principle of operation is quite different from that tube too. Like a klystron, the traveling wave tube is well adapted for use as an amplifier as well as an oscillator. This is not true of magnetrons; they are, at least generally speaking, only useful as oscillators and in fact are normally used only for producing high level signals such as those which are needed in a radar transmitter. Like the klystron, the traveling wave tube can be used to amplify a low-level microwave signal provided only that the signal strength is greater than the intrinsic noise introduced by the tube. To date this matter of noise is not completely satisfactory in either the klystron or the traveling wave tube.

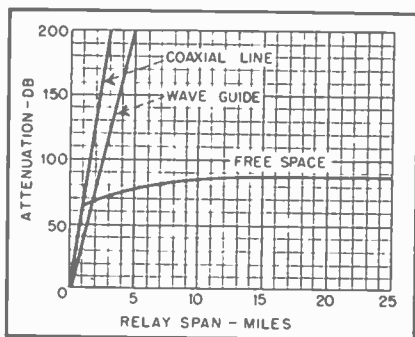

Fig. 1. Relative attenuation of microwaves in free space and in transmission lines. Magnetron

Neither tube shows much promise of allowing r-f amplifier stages to be built into a receiver as effectively as they are in receivers designed for use in the lower frequency part of the radio spectrum. This, however, is by no means fatal to the use of microwaves for relay service.

When a radio link is to be used to supplant a cable of wires or a coaxial line, high signal-to-noise ratios must be held at all points. The fidelity requirements are quite stringent because any distortion that is introduced is of course cumulative from relay to relay. This condition in turn means that the receivers are not required to work on extremely low level signals. Because of the high gain antennas (sharp beams of radiation) and because the line-of-sight properties of microwaves generally limit the relay spans to 30 miles or less, such relatively high level signals into the receivers are easily obtained.

So much has been said of the superior transmission properties of coaxial lines and wave guides that it is easy to lose sight of the fact that neither is as good as free space. Their advantages are nearly always quoted in terms of other more conventional types of transmission line. Whenever a conductor is present, whether it be in wave guide form or distributed along the transmission path in some other way, currents will flow in that conductor and the resistance accentuated by the skin

effect will take its toll and contribute to the attenuation of the signal. In radio transmission through free space there are no such conductors and the only attenuation which is encountered is of a geometric nature associated with the spreading of the energy over larger and larger areas. Fig. 1 shows this attenuation situation as it exists for two sample transmission line installations and for line-of-sight radio transmission. It indicates that relative to transmission lines, economic considerations do not necessarily demand extremely long relay spans.

## Comparison with Magnetron and Klystron

The invention of the traveling wave tube is generally attributed to the English and is a direct outgrowth of a wartime project which, however, had to be somewhat limited in the face of other more pressing tasks. British engineers have emphasized the noise features of the tube in their research. Apparently the Bell Laboratories are the first to realize that other advantages, such as efficiency and broad band width, might be even more important.

It does not appear likely that the traveling wave tube will make the magnetron and the klystron obsolete in the foreseeable future. Each would seem to have uses for which it is certainly superior. There are also some applications where it is not yet known which type is best. The lineup at present would seem to be about as follows:

### Magnetron

To obtain extremely brief but high powered pulses of microwave energy the multiple cavity magnetron is by far the best tube available. Although the cathode structure of the magnetron must be kept extremely small and is therefore always a vulnerable point when continuous operation is needed, no such difficulty is met under pulse conditions. The magnetron has never been successfully modified so as to be useful as an amplifier or frequency

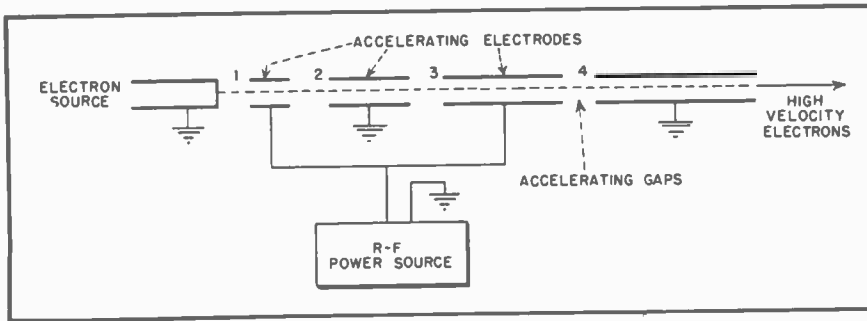

Fig. 2. An electron accelerator design using multiple accelerating paths.

multiplier. It cannot be easily used either for frequency or amplitude modulation systems. For radar or pulse time modulation transmitters, however, it is unquestionably the best type of tube to use.

#### Klystron

The klystron is an extremely versatile tube because it can be used in almost all the functions of ordinary triodes, screen grid tubes, and pentodes. In particular, it can have an output circuit which is tuned to a frequency different from that of the input circuit and hence can act as a frequency multiplier. This property in conjunction with its operation as an amplifier makes it quite possible to use klystrons with a precise crystal oscillator to yield microwave signals which have a very accurately known frequency. This is in contrast to the very rough frequency control obtainable with the ordinary magnetron and the still fairly rough accuracy possible with the best control schemes. The peak power of the klystron is much less than that of the magnetron although its average power is comparable. Its band width as an amplifier is restricted to a few megacycles although the construction of tubes to operate over any chosen few megacycles up to frequencies as high as 25,000 mc is quite feasible. Klystrons are particularly adaptable to use with frequency modulation.

#### Traveling Wave Tube

Development has not yet reached the point where performance in all classifications can even be intelligently guessed at. There is every reason to believe that operation as an oscillator as well as an amplifier is relatively easy. Frequency multiplication using the traveling wave tube would not appear to be very straightforward but may be possible. Great band width, good efficiency, and high gain seem to be the most likely virtues of this tube. There seems to be some indication that the traveling wave tube will be easiest to build only for frequencies in the neighborhood of 4000 mc. At both

higher and lower frequencies the dimensions required introduce difficulties.

#### Operational Theory

In just about all vacuum tubes, operation depends upon transferring energy from an electron beam into an r-f field. In a magnetron oscillator, for example, electrons from the cathode are accelerated because of a d-c voltage on the anode. During their acceleration they accumulate kinetic energy from the d-c source and a magnetic field simultaneously causes them to rotate around past gaps that are cut into cavities which form part of the anode structure. The nature of the tube geometry and the d-c voltage is such that most electrons pass by the gaps at times when the r-f field there decelerates them. As they slow down they lose kinetic energy. The energy that is lost to the electron is gained by the r-f field which is strengthened in consequence. A single electron may pass several cavity gaps and give up energy to the cavities several times before drifting out of phase and losing its usefulness in the tube.

In a klystron, a similar situation exists. Electrons from the cathode are initially accelerated by a d-c field and hence given energy by virtue of their velocity. In a multiple cavity klystron, the electrons then pass through a cavity where their velocity is slightly modified. After traversing a drift tube this slight velocity modification is sufficient to cause the electrons to be bunched and phased so that they suffer deceleration by virtue of the r-f field existing in the final cavity. Thus again kinetic energy of the electron is transferred to the r-f energy in the tube output circuit.

The traveling wave tube also builds up its output signal with energy taken from the kinetic energy of the electrons in an electron beam.

#### Electron Accelerators

A reverse example of the transfer of electron kinetic energy into r-f field energy is that of the so-called electron accelerator tube. It is a device which uses a relatively low voltage and applies it repeatedly along the electron path so as to give the electron a very high velocity. Such high velocity electrons are useful for producing hard X-rays.

Electrons as they are boiled off a cathode surface have relatively small velocities. If, however, an anode is placed near the cathode, the electrons will be attracted by the positive potential of the anode and will gain velocity during their travel toward that electrode. If the anode voltage is  $E$  volts, the electron velocity will be given by  $(1 - v^2/c^2)^{1/2} = 1/2 \times 10^{-6} E + 1$  where  $v$  is the electron velocity and  $c$  is the velocity of light. To obtain  $v/c$  values of more than a few tenths, inconveniently large values of  $E$  must be used.

Figure 2 shows how an electron accelerator tube may be constructed so as to avoid this difficulty. A single voltage obtained from an r-f source is used to accelerate each electron four times. The electrons travel from left to right. Those which emerge from the electron source when the r-f voltage is positive are accelerated through gap 1. By the time they reach gap 2, the r-f voltage has changed polarity so acceleration is incurred there also. The various accelerating sections successively increase in length so that equal time intervals elapse between the transits of the various gaps. The polarity then has changed again when the electron reaches gap 3 and still again when gap 4 is reached. Thus the electron is accelerated four times by the r-f voltage and  $E$  in the equation just stated has the effect of being 4 times as great as the r-f voltage actually used.

Such a method of accelerating electrons is a rather exact reverse of a method of slowing down electrons and absorbing the energy into an r-f voltage. As a matter of fact, the gap method just explained is closely an-

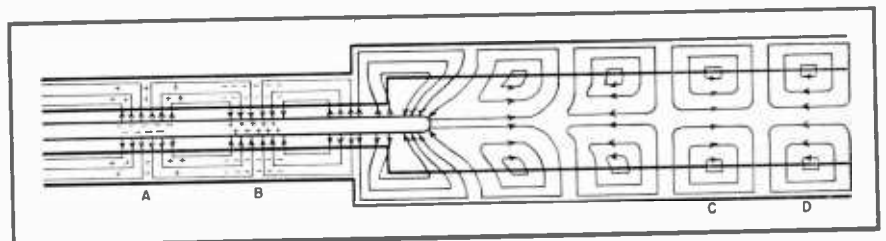

Fig. 3. Launching a traveling wave into a wave guide from a coaxial line.



alogous to the operation of a klystron. There pairs of grids are used to collect the r-f energy just as gaps are used here to feed in the r-f power. Velocity modulation of the electron beam is simply a method of causing the electrons to reach the gaps (i.e., pairs of grids) in bunches and at times when they will strengthen the r-f field rather than be accelerated by it.

### Traveling Wave Accelerator

The electron accelerator tube just mentioned speeds up the electrons only during the successive brief intervals that they are in the gaps between the electrodes. It is natural as a next step to see if there is not some way to cause the acceleration to take place all along the tube. In other words, it is desirable to see if there is not some way to make the condition, which periodically occurs at each gap, be one that moves down the tube along with a certain group of electrons so as to constantly urge that group of electrons to move faster and faster. This situation in which a voltage gradient in a

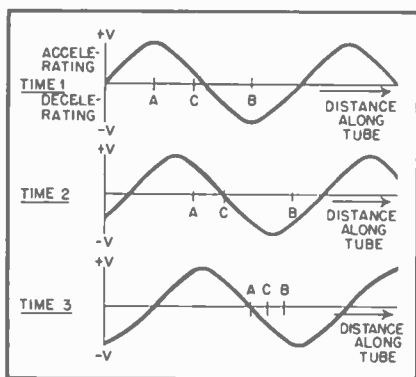

Fig. 4. Electron action along a traveling wave tube.

given direction moves along a transmission line is precisely what happens in a traveling wave. Neglecting such practical details as that of finding a method to make the wave go slowly enough and to gradually speed up to keep pace with the electrons, the problem is an easy one.

In Fig. 3 is shown one way in which a suitable traveling wave might be launched down a hollow tube in a way that would accelerate certain electrons travelling along with it at nominally the same velocity. The launching arrangement consists of a coaxial line carrying the r-f power and terminated into a piece of cylindrical wave guide. The center conductor of the coaxial line extends a short distance into the wave guide and then ends in the way shown. In a practical device the center conductor itself would have to be hollow and a beam of electrons projected through it into the active field of the wave guide.

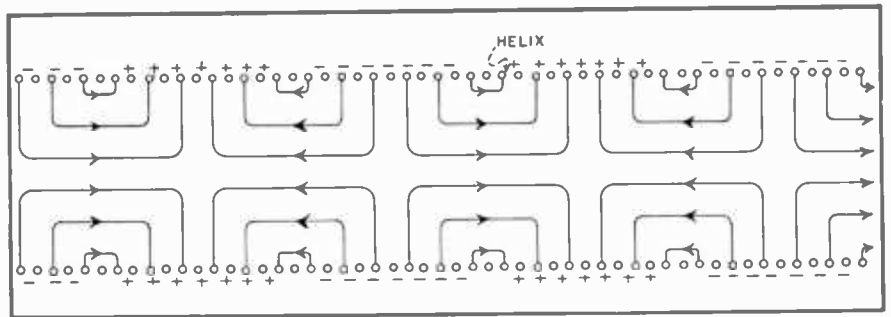

Fig. 5. Use of helix as walls of a wave guide to decrease greatly the propagation velocity.

At the left end of the coaxial line section shown in Fig. 3, the r-f voltage is applied between the center and outer conductor. This means that for each alternate half-cycle, a positive charge is supplied to the center conductor and a negative charge to the outer conductor. During the other half-cycle periods the polarity is reversed. As these groups of charges move along the line, so also does a region in which any electron between the conductors would be attracted to one of the conductors. For example, if an electron were placed between the coaxial conductors at a place such as *A*, it would be momentarily attracted to the outer surface as is shown by the arrows. If the electron had no velocity, the attraction would be very short lived because the conditions of region *A* would have moved on to the right, and even a region such as the one at *B* would have come in from the left and have caused an opposite force to be present at *A*. On the other hand, if the electron were moving from left to right through the inter-conductor space at a speed approximately equal to that of the r-f voltage, the electron might keep up with the condition shown at *A* and be continuously attracted to the outer conductor and absorbed there.

Such an arrangement for lateral deflection of electrons in a coaxial line space is of no value, but when the same logic is applied to the wave guide section, two conditions of great value are possible. One occurs when electrons of interest move along with regions like the one instantaneously shown at *C* in Fig. 3. Such electrons are continuously accelerated and may under certain conditions be made to obtain very large energies. The other occurs when the electrons of interest move with regions like the one shown at *D*. Such electrons are constantly being slowed down and are constantly giving up energy to the r-f field. This is what happens in the British and Bell Laboratory tube known as the traveling wave tube.

### Electron Distribution

From what has been said, it is apparent that the difference between a traveling wave accelerator and a traveling wave generator of r-f energy lies not only in whether d-c or r-f energy is supplied, but also in causing the electrons of interest to be those which move along in a certain phase relation to the traveling wave. To generate r-f, one would ideally like to have the electron source emit bunches of electrons which would travel along with the decelerating regions of the traveling wave and give off no electrons to go along with the accelerating portion hence draining energy from the r-f field. If such an electron source could be obtained there would be no need for the tube. The electrons themselves would supply the needed r-f current. Fortunately, however, the traveling wave tube does not require any such electron source in order to operate. Possibly a rough bunching of this sort in the electron source could be obtained by using klystron techniques and would be helpful. But operation is normally accomplished without any special attention to the electron source except to cause it to emit as many electrons as possible and to supply d-c voltage in the gun assembly which will give the electrons the necessary kinetic energy to transfer to the r-f field.

In Fig. 4 the conditions along the length of the tube are shown in a somewhat less pictorial way than in Fig. 3. Three sine waves are drawn and in each one the portions above the axis represent a region in the tube where electrons would be accelerated while the portions drawn below the axis show where deceleration will take place. In the first curve, for example, the portion of the tube at the extreme left (next to the electron gun) is one where electron acceleration takes place. The center part is one of decelerating properties and the right-hand end is again an accelerating region. In actual practice, a large number of such regions would exist and the drawing would

[Continued on page 30]

# FREQUENCY SHIFT

CHRIS BUFF

Field Engineer, Press Wireless Mfg Corp

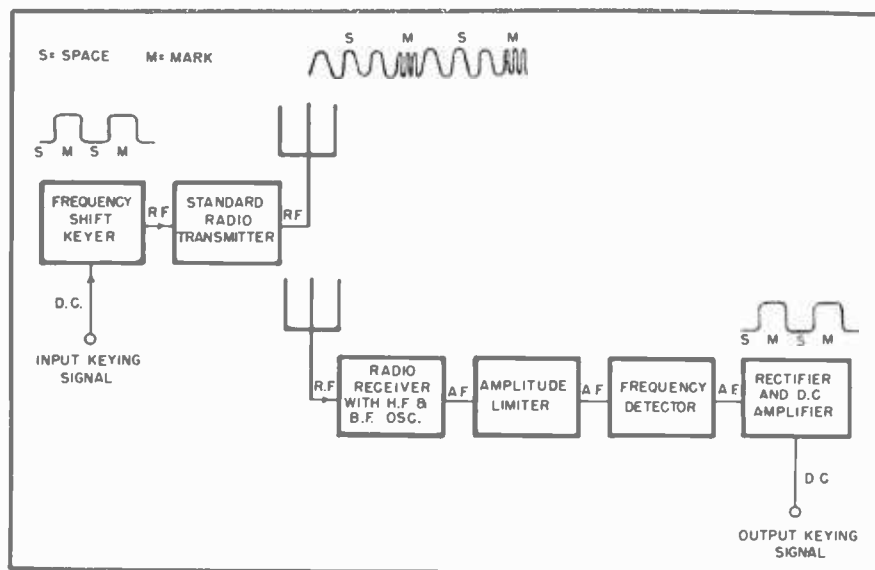

Fig. 1. Block diagram showing essentials of a frequency-shift keying system

FREQUENCY SHIFT keying of radio-telegraph transmitters was used in the early days of radio communication when the arc transmitter was in its prime. Because the arc, once started, could not be keyed on and off fast enough for practical communication, means were used to shift the output frequency in accordance with the telegraphic code. This usually consisted of a heavy relay-contacter which shorted intermittently part of the frequency-determining tuning coils, thus varying the frequency many kilocycles. An operator tuning to one of these frequencies could copy all the key-down or "marking" signals which normally were used to carry the intelligence. The "spacing," or key-up, signals could not be heard at the same setting of the receiver, but if the operator tuned to the spacing frequency he could copy all the spaces between characters, letters, and words. If he had had enough practice in copying the spaces he could copy the same intelligence on either frequency!

In those days, however, the state of art was such that only the key-down, or marking, signals were normally used to receive the intelligence. Frequency-shift keying was then only a means to an end. Today this method of keying is fully utilized with both the marking and spacing frequencies playing equal roles, resulting in a method of telegraphic communication which is inherently less susceptible to fading, noise, and other transmission vagaries.

Frequency-shift keying may be called the telegraphic counterpart to frequency modulation as applied to broadcasting.

## Advantages of Frequency Shift

The gain in signal-to-noise ratio of frequency shift versus on-off keying has been variously estimated to be between 11 db and 20 db. Different methods of detection over various transmission paths probably account for most of the discrepancy. The 11-db figure was arrived at by comparing a dual-diversity f-s system with a triple-diversity on-off system and is considered to be on the low side because it is known that under certain multipath conditions the addition of the third receiver will increase the signal-to-noise ratio gain by 3 db or more.

The f-s system provides the greatly increased signal-to-noise ratio necessary for reliable radioprinter operation without necessitating transmitters of tremendous powers. In general, all transmitters in use for on-off keying may be converted to automatic printer by adding the frequency-shift keyer unit and provide reliable radioprinter service without any increase in power.

If transmitter carrier power were

depended upon to realize the increase in signal-to-noise ratio required, it would mean that powers exceeding 100,000 watts would have to be used on most circuits.

An important operational advantage results from the fact that the transmitter output keying wave shape can be made identical to that of the input keying signal. The slopes and mark-to-space ratios can therefore be readily adjusted before entering the transmitter and will be exactly the same when they leave the antenna. This is so because the Class C amplifiers, which usually are not of too high a Q, form a linear system for frequency modulation having the narrow deviation used for this method of keying.

With on-off keying of a low-power stage in the transmitter, the final output wave shape can never be precisely adjusted because of the limiting action of Class C amplifiers which keep squaring up the wave in each successive stage, so the final wave shape is never identical to the input signal.

Excessively squared waves with steep rises and decays cause transients which increase the bandwidth greatly beyond that which is required for the speeds being transmitted. Adjacent channel

operation is more unpredictable because day-to-day neutralizing and biasing adjustments on any given on-off keyed transmitter are closely related to the amount of key clicks and transients produced.

With f-s operation the carrier is not interrupted. This greatly minimizes the chances of transients being generated due to slight neutralization or bias misadjustments on any frequency, in any stage of the transmitter.

## Basic System

Although there are several methods of producing frequency shift signals at the transmitter and of converting them at the receiver, Fig. 1 shows the elements common to all frequency-shift systems. These are the frequency-shift keyer at the transmitter which takes ordinary on-off d-c or tone pulses and converts them into two distinct radio frequencies, the amplitude limiter at the receiver which levels out fading signals, the mark-and-space frequency detectors, and the differential rectifier which changes the mark-spaced audio tones into positive and negative d-c values for rekeying a d-c amplifier.

The effectiveness of this system may be enhanced by introducing a band-pass

# KEYING TECHNIQUES

Circuit data and design factors of the new frequency-shift transmitters are discussed

filter ahead of the limiter to restrict the frequencies accepted by the limiter to those needed to detect the desired intelligence. The design of this filter must take into consideration the following factors:

1. Value of frequency shift.
2. Maximum keying speed.
3. Maximum drift in transmitter and receiver.

Secondly, a low-pass filter in the final d-c output of the converter may be used to eliminate any transients above the maximum keying frequency. The design of this filter may be governed solely by the maximum keying speed, taking into account the passage of only those harmonics of the keying frequency necessary for adequate fidelity of copy.

The use of band-pass and low-pass filters may also be applied to on-off keying systems.

For all types of telegraphic communication, including automatic printers, a two-frequency shift keyer and converter will suffice. That is to say, it is not necessary to have a linear relationship between the amplitude of the

input keying signal and the output frequency at the transmitter nor the output frequency of the receiver and the rectified output of the converter. The use of frequency shift, however, is proving of advantage, with respect to economy of operation and fidelity of transmission, for facsimile and radiophoto work. For these applications a linear system is required which will convey all the gradations between black and white by means of discrete frequencies.

While some success has been achieved for ordinary telegraph frequency shift by using two crystals differing slightly in frequency and alternately keyed by means of an electronic switch or mechanical relay, such a system is of no value for radiophoto or facsimile work. Fig. 2 shows a block diagram of a frequency-shift keyer which has proved very successful with both types of signals.

## F-S Transmitting Keyer

On-off d-c telegraph signals are applied to the keyer-limiter circuit which keys a pre-set regulated voltage to the reactance tube grid. This circuit is so

arranged that any variations in the amplitude of the input keying signal above a minimum threshold level will not alter the predetermined frequency shift produced by the reactance tube on the 200-ke oscillator.

The reactance tube itself should be considered part of the 200-ke oscillator circuit since its presence affects the frequency, stability, and  $Q$  of the oscillator. Fig. 3 shows a reactance-tube-oscillator circuit which produces a linear frequency swing and has good stability. This circuit is unique in that it makes use of the grid-plate capacities of the reactance tube (6SN7) to form part of the  $90^\circ$  phase shifting network necessary for proper operation of the circuit. The circuit is biased so that positive and negative voltages with respect to zero volts input, will produce negative and positive frequency swings. An increase in positive bias results in a decreased capacitive reactance being presented to the oscillator tank circuit, lowering the frequency. For negative voltages the converse is true. Fig. 1 shows the frequency shift characteristic obtainable with this circuit.

For facsimile and radiophoto operation the d-c keyer-limiter stage is not used and the linear d-c pulses are applied directly to the reactance tube grid circuit.

Because of the excellent linearity obtained and the fact that no current is drawn by the reactance tube grid, it is possible to use a frequency-shift dividing resistor network to reduce a basic predetermined frequency shift to any value desired. Frequency multipliers in the transmitter multiply the shift as well as the carrier frequency, ordinarily necessitating a readjustment of the frequency shift control potentiometer each time the number of frequency multipliers is changed.

With the circuit shown a basic output carrier shift, for instance 600 cycles, may be divided into any number of subdivisions, each selected by a switch contact. Multiplication in the transmitter brings the shift back to the desired value (600 cycles) on the final output frequency.

A dividing network calculated to provide subdivisions of  $1/2$ ,  $1/3$ rd,  $1/4$ th,  $1/6$ th,  $1/8$ ,  $1/9$ th, and  $1/12$ th the basic shift will accommodate the multiplying stages of practically all transmitters in existence.

Since the system is linear and no current is drawn from any of the taps, the resistor values may be readily calculated, being exactly proportional to the frequency-shift divisions desired.

The push-pull, 200-ke oscillator energy is applied to the grids of a balanced mixer stage where it is combined with energy from a high-fre-

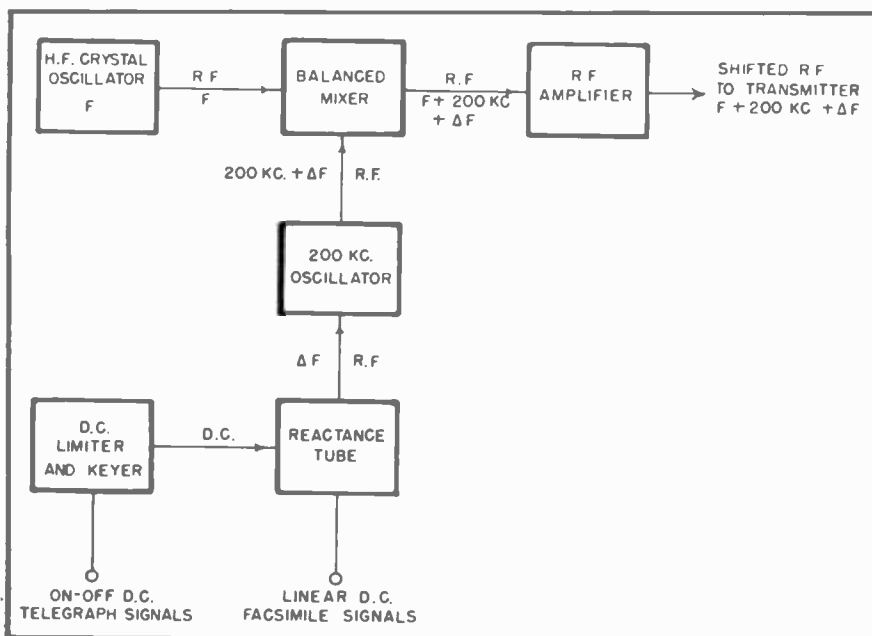

Fig. 2. Frequency-shift keying system which may be used for either code or facsimile transmission



quency crystal oscillator operating 200-ke lower than the desired fundamental output frequency. The plate circuit of the mixer stage may be tuned either to the high sideband, crystal carrier, or low sideband frequencies. In the interests of standardization the high-frequency sideband is normally used as the output frequency. Through the use of a balanced mixer circuit with a plate current balancing control the crystal carrier may easily be reduced to 50 db below the sidebands in the 2 to 4 mc range.

The high-frequency sideband is then amplified and transmitted by coaxial cable to the buffer-amplifier stage in the transmitter.

Succeeding stages in the transmitters are tuned to resonance exactly as for on-off keying and the power input is adjusted for continuous key-down operation.

### F-S Receiving System

Several types of frequency detectors are in use for converting frequency-shift signals back into on-off pulses for actuating automatic printers, ink recorders, and facsimile equipment. In order to obtain the required stability, the detection is usually accomplished at audio or frequencies below 100-ke. Unattended receiver operation requires that the high and beat-frequency oscillators be crystal controlled or controlled by master oscillators having stabilities approaching those of AT-cut crystals, temperature-controlled.

Systems which permit operation with unstable oscillators, do so with great sacrifice in the signal-to-noise ratio because the input band-pass filter must then accept the widest possible drift band with its attendant decrease in noise rejection.

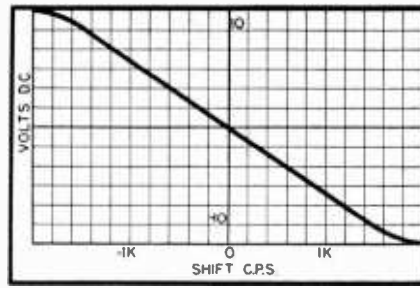
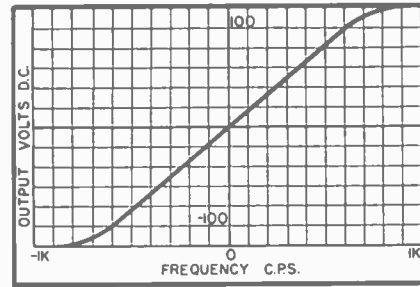

Fig. 4. (Above) Voltage input vs. output frequency for circuit of Fig. 3. Fig. 5 (Below) Audio discriminator characteristic suitable for facsimile application



Space diversity technique may be used to great advantage with frequency-shift telegraph signals. In most systems each receiver is followed by an f-s converter channel consisting of an amplitude limiter, a frequency detector, and a differential rectifier. The two channels are combined after rectification by means of a gating system which allows the stronger of the two signals to pass and rejects the weaker. Direct combination of the receiver outputs is not feasible because phase shifts existing between the two signals due to multipath conditions may cause partial or complete cancellation of the signal or produce severe distortion of the keying signal. After rectification to d.c., the phase shifts represent only a

small fraction of the total pulse lengths and are, therefore, usually not detrimental to keying speeds up to approximately 600 w.p.m., or 240 cps. Because of the high keying speeds used for facsimile and photo-transmission (up to 800 cps) multipath phase shifts cause severe distortion even when diversity action is affected in the d-c stage. Therefore, dual diversity operation is not used for the reception of these signals.

Figure 5 shows an audio discriminator characteristic which is suitable for the translation of frequency shift facsimile and photo signals into d-c amplitude variations which control the recording lamp. Values of frequency shift commonly used for facsimile are 900 cps and 1200 cps. For facsimile work, the gating system and d-c amplifiers shown in Fig. 6 are not used. Linear d-c voltages may be taken directly from the discriminator, passed through an appropriate low-pass filter, and used to actuate a tone keyer which produces an output frequency whose amplitude is directly proportional to the d-c input. The input circuits of most facsimile and photo-recorders operate with an amplitude-modulated tone input.

### Frequency Stability

Frequency detection in the standard communications spectrum of from 2 to 30 mc implies the use of a high frequency-stability system in order that the FCC tolerances originally assigned for make-and-break keying shall not be exceeded when frequency-shift keying is used. The standard FCC frequency tolerance for most point-to-point radio-telegraph transmitters is  $\pm 0.1\%$ . Until frequency shift keying is more adequately defined by the FCC and new tolerances are set up, certain communications companies are bound to adhere to the present  $\pm 0.1\%$  figure. This means that the total bandwidth of a frequency shift transmitter must lie between these limits. At the present time, frequency shift is considered to be a form of A1 emission using an unstable oscillator! Actually the stabilities required of the mark-and-space frequencies are much greater than those required for make-and-break keying.

During the war, an 850-cycle frequency shift was decided upon and used by most of the military services. This has proved to be a good choice so far as overall performance goes and probably took into consideration the limitations of frequency stability of the equipment in use at that time.

For commercial services between 4 and 30 mc a 600-cycle shift has been found to result in no deterioration of

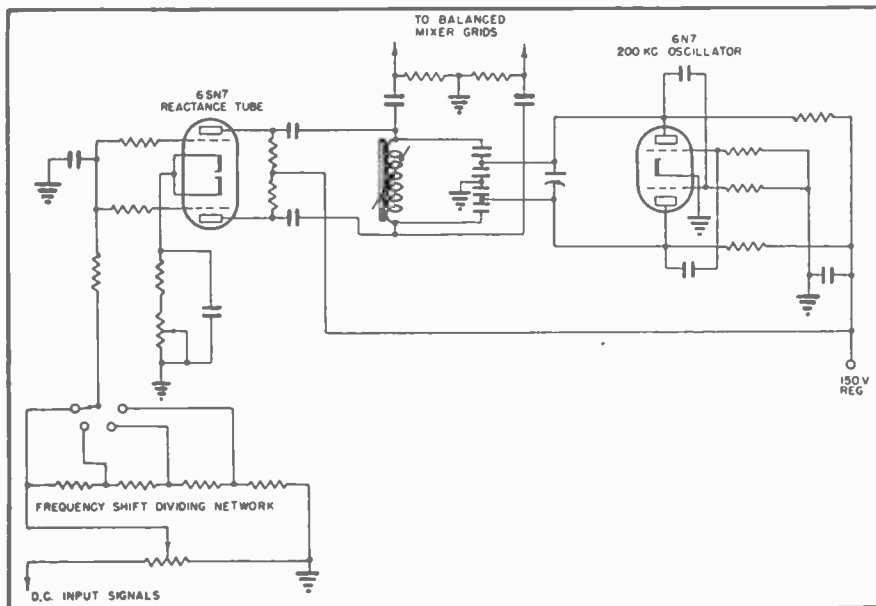
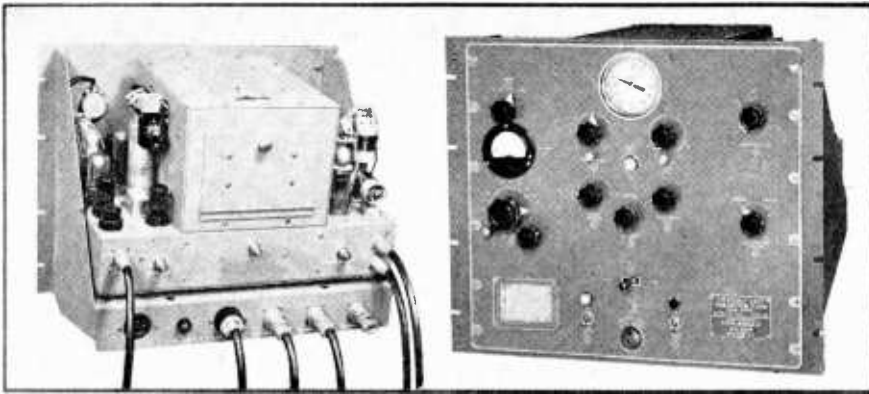
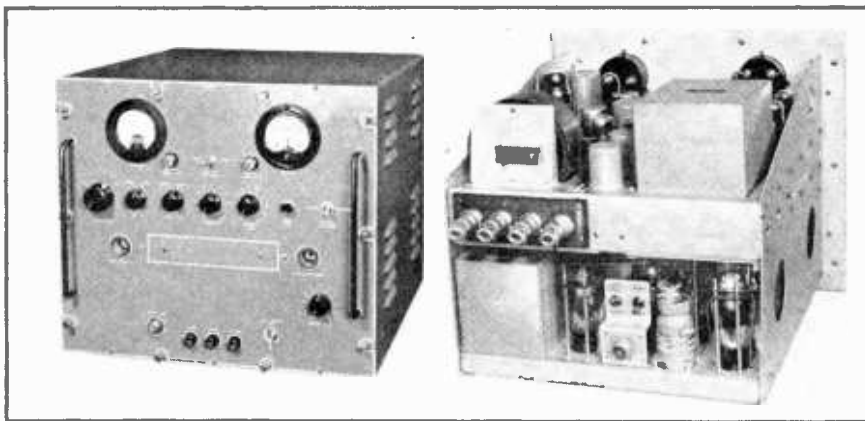

Fig. 3. Linear frequency shift and high stability are realized in this reactance-tube oscillator circuit



(Above, left) Rear view of frequency-shift transmitter keyer. (Above, right) Front view. (Below, left) Front view of frequency-shift converter. (Below, right) Rear view.



signal-to-noise ratio gain and is widely used. This figure was arrived at to meet the FCC .01% tolerance requirement as well as an endeavor to cut down the bandwidth required to the minimum necessary to maintain a given grade of service.

The stability of frequency-shift keyers of the type described and illustrated by Fig. 3 is dependent for the greater part on the design and temperature control of the reactance tube-oscillator circuit considered as a unit. The high frequency crystal oscillator, which is mixed with the 200 kc frequency to obtain a shifted high frequency, employs an AT cut crystal, also temperature controlled, and contributes negligible frequency drift. Present equipments employing this principle maintain a stability of  $\pm 6$  cycles on the 1 to 6 mc range over an operating period of 6 hours or more.

In actual commercial operation the mark and space frequencies are checked at least once every twenty-four hours by means of a primary or secondary frequency standard. It has been determined by these measurements that the 200 kc oscillator usually requires no frequency readjustment over periods of a week or more.

A-C line fluctuations of  $\pm 10\%$  reflect no more than a  $\pm 6$  cycle change on the output frequency.

Improved temperature over design techniques are now available which will greatly reduce even the present drift due to ambient temperature changes. Small ovens suitable for this type of equipment have been constructed which maintain constant temperature within .3 of 1°C or better with a change in the ambient of from 0° to  $\pm 50^\circ\text{C}$ .

In order to achieve the required stability without using temperature control it is necessary to place the reactance tube-oscillator circuit on a frequency lower than 50 kc. This means that two or more frequency conversions must be performed to obtain 1 to 6 mc output frequencies with sufficient attenuation of undesired sidebands. Despite the additional converter stage, this system has considerable merit in that it eliminates costly oven construction.

Whichever method is used it is apparent that the reactance tube principle of producing frequency shift keying has many advantages over all existing methods. Among these advantages are the following:

1. Wave shaping is easily accomplished in the grid circuit, minimizing undesired transients and permitting minimum bandwidth for a given keying speed.
2. An excellent linear characteristic is obtainable which allows the use of the system for photo and facsimile transmission.
3. The system is very flexible. Any value of frequency shift may be set up and divided as required. Standard high frequency crystals may be used in the high frequency oscillator and the characteristics of these have no bearing on the keying or frequency shift.

It is pointed out that direct or indirect phase modulation of crystal oscillators as applied in frequency modulation systems for voice and program frequencies is not applicable to frequency shift telegraph or facsimile keying. This is so because, for the latter operations, the modulation or keying frequency must go down to zero. That is, discrete frequencies representing either the Mark or Space signals, must be able to be maintained for an indefinite period which may be seconds, minutes, or hours.

Phase modulation systems are based on a definite lowest modulation frequency usually 15 to 30 cps and are, therefore, not suitable for this purpose.

The design of frequency shift receiving equipment offers no great problems as far as frequency stability is concerned because the conversion can readily take place at audio frequencies or very low radio frequencies 50 kc or lower.

Attempts made to discriminate directly at standard intermediate frequencies, such as 465 kc, have met with little success due to mechanical and thermal instabilities of the discriminator at these frequencies.

The reduction of frequency-shift  
[Continued on page 30]

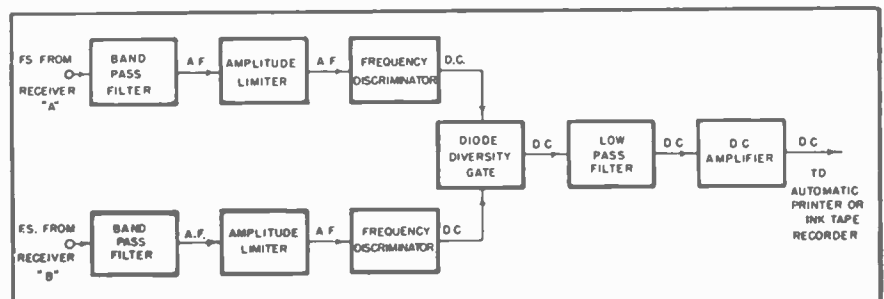

Fig. 6. Block diagram of dual diversity receiving system

# NOTES ON

A. C. MATTHEWS

ALL RECEIVER design engineers need a quiet spot in pleasant home-simulated surroundings in which to listen to their newly developed models. Many far-sighted manufacturers provide such facilities in the form of a field laboratory; others either require or permit the engineers to take the receiver home for these tests. The remainder provide no facilities, but depend upon listening tests made in the laboratory under far from normal operating conditions. Sooner or later customer complaints will convince these manufacturers of the need for special facilities.

The field laboratory is not only an ideal proving ground for a company's product but it can be used for many other purposes if intelligent planning has gone into its layout. Besides the regular listening rooms, which should be furnished as nearly like a regular living room as possible, there should be at least one extra large room suitable for small "get-togethers", where conferences can be held by engineering, sales, or management. But the main objective is to provide a suitable listening post which approximates an average residential home and to provide some laboratory facilities for making comparison measurements of receivers. When possible, a comparison should be made between all new designs and a representative sample of previous designs or perhaps a competitive manufacturer's current production. Listening posts should be made under as nearly normal living room conditions as practicable, particularly if tonal fidelity is being checked. Unusually high electrical or aural background noise masks the program and makes it difficult to listen critically. For this reason approximate home conditions are preferred.

## Facilities Required

The laboratory building can be designed on a single floor plan, although the heating facilities could be located in a small basement if desired. The building shown in the sketch (*Fig. 1*) is of cinder block construction with glass brick for decorative effect and privacy. A second floor is not recommended because of the inconvenience of moving apparatus from one floor to another.

The amount of floor space depends upon the size of the particular engineering department and the extent to which it will make use of the field laboratory. There is always a tendency to provide too little floor space, therefore this point should be carefully considered. An extra listening room costs very little additional if included in the original plans but if it must be added later the expense involved is sometimes prohibitive. Past experience has shown that a field laboratory becomes increasingly popular with the design engineer as he discovers the speed with which he can solve certain acoustic problems when a quiet working space is available.

## Antennas

If the company is engaged in manufacturing farm receivers, then a typical farm antenna should be erected. Television, FM and other high-frequency

receivers of course require adequate dipoles or other forms of high-frequency antennae. An easily erected mast of 20 or 30 feet will also come in handy in case antenna systems are to be studied. This should be well in the clear in order to eliminate reflections from nearby buildings.

## Equipment Required

Next, the actual required measuring equipment should be decided upon. This should include AM and FM signal generators for all frequencies ordinarily used, together with a-c oscillators to modulate same. Obviously a separate variable audio oscillator will not be required for each generator but it is advisable to include at least three since in this way audio investigations can be carried on simultaneously by another group without loss of time in waiting for equipment. Several vacuum tube voltmeters and output meters should be provided. At least two oscilloscopes will also be found invaluable. Of course, a supply of small components such as resistors, capacitors and hardware are an absolute must as is a complete range of a-c and d-c meters.

Several types of switches should be provided for switching antennas, receivers and speakers. A few of the more common types are shown schematically in *Fig. 2*. Note that indicating lamps are included to assist untrained personnel in following the switching during demonstrations.

Portable acoustic measuring equipment can be set up in the rear of the building for speaker measurements if the building is located in a quiet neighborhood. Outdoor measurements are superior to those made indoors because of the absence of undesirable reflections.

As for tools, some companies insist that each engineer bring his own from the main laboratory, others supply a fairly complete complement which always remains on the premises. The latter method is to be preferred. Electric bench-type drill presses and similar equipment are not required since major changes should be made at the main plant where more complete facilities are available. A small hand drill, however, will often come in handy if minor changes are necessary.

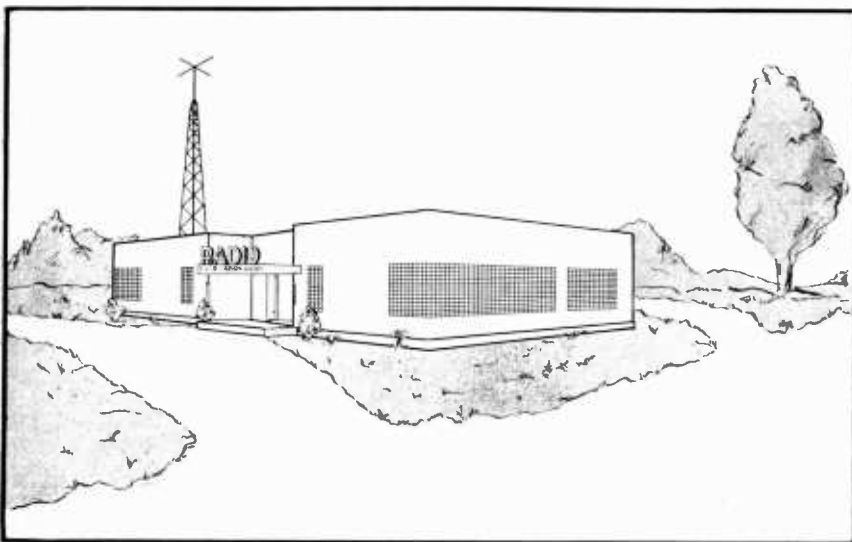

Fig. 1. Perspective view of field laboratory.



# FIELD LABORATORY DESIGN

Useful information on the design and construction of a field laboratory

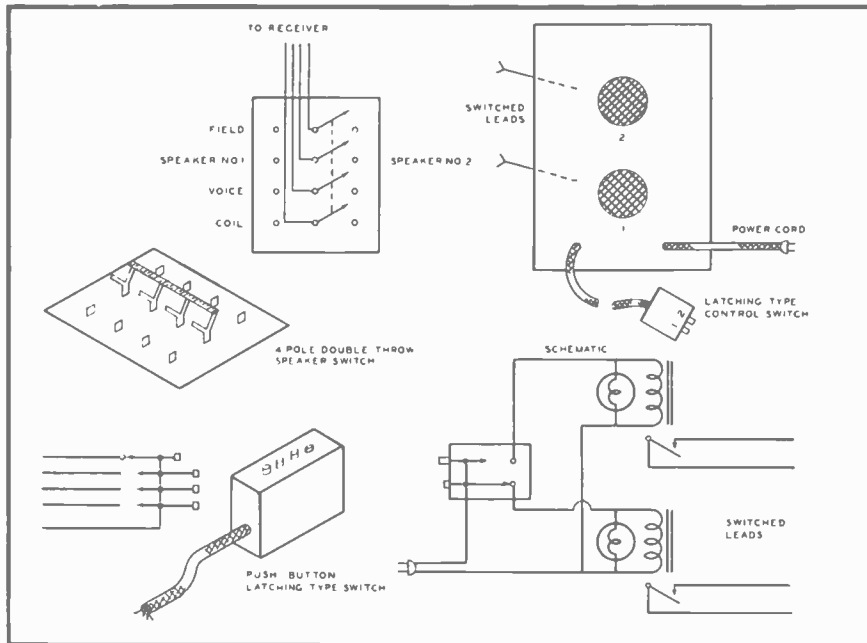

Fig. 2. Details of switching arrangements for comparison tests.

Each listening room should be furnished as a typical living room with rugs, drapes, tables, over-stuffed furniture, floor lamps, etc. One or two "tea wagons" should also be provided for measuring equipment. In addition to the normal living room furniture a supply of folding camp chairs often are useful, especially when a demonstration is to be given. The workroom should be equipped with cupboard space to hold the unused equipment and supplies.

## Maintenance

A junior engineer can be assigned to check the supplies, ordering new components as required. He can also check the measuring equipment from time to time to see that it is maintained in good order. Unless an automatic heating system is available a janitor or caretaker will be required daily.

## Actual Layout

A typical floor plan is shown in Fig. 3. There are actually four listening rooms since the sound-proofed room can be used if necessary. Such a layout should be adequate for even the largest radio receiver manufacturer since the building is to be used only for listening

tests and demonstrations. The main room with 1000 square feet of floor space is adequate for demonstrating several receivers to a fairly large audience. Such a room can be used by management and engineering to demonstrate new advances in the line.

Telephone facilities should be located nearby, but not actually in the room, since this can often be a disturbance during demonstrations or talks. At least two doors should be included because of the size of the room. This facilitates the moving of equipment or receivers to the storage space without unduly disturbing the audience. Built-in seating along the front and part of the side of the outer wall will be found very convenient in many instances.

A storage and utility room located close to the main demonstration room provides a convenient place for storing receivers which are not actually being used, but are required for tests from time to time; as for instance, competitive models and samples of the previous year's production. This room should also include heating and air conditioning equipment for the entire building. A cloak closet has been centrally located in the main vestibule and at the rear of the

building space has been provided for toilet facilities.

To the left of the ten-foot wide vestibule, when entering the main door, are located two smaller listening rooms. These are approximately the size of an average living room and, like the main demonstration room, should be completely furnished to approximate normal home conditions. Without adequate furniture a room will tend to have too much reverberation and therefore will be misleading to the listener.

At the rear of the building space has been provided for a small laboratory with a connecting sound-proof room. The former can be used for making minor changes and measurements while the latter is ideal for hum or low level distortion tests. Equipment as previously described should be available for these rooms.

Many refinements can be added to these plans such as attractive pilot lights at each door to indicate when the power is turned on, a paging system for the telephone, photo-electric door openers, a high quality line to a local broadcasting station for comparison purposes, etc.

The antenna tower, as shown, is optional and may be located in the rear of the building as will other antennas if required. A driveway should be provided at the rear of the building to facilitate loading and unloading heavy equipment.

The cost of a field laboratory as described should not be prohibitive, especially since it helps insure maintenance of a high-quality product from year to year by permitting comparisons to be made under actual operating conditions.

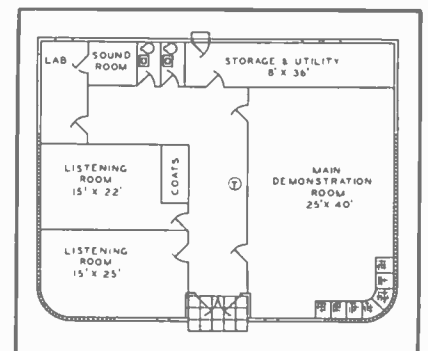

Fig. 3. Floor plan of field laboratory.

# RADIO DESIGN WORKSHEET

## NO. 51 – GRAPHICAL ANALYSIS OF THE CATHODE – COUPLED AMPLIFIER; SYMMETRICAL T AND H ATTENUATORS

### GRAPHICAL ANALYSIS OF THE CATHODE-COUPLED AMPLIFIER

Yielding double-ended output from single-ended input, the two-tube cathode-coupled amplifier circuit shown in *Fig. 1* may be conveniently analyzed on the published plate family. Details of the operation may be thus evaluated to a considerable degree of precision.

$V_1$  and  $V_2$  are usually the same tube type, and the analysis is made upon this basis.  $V_2$  derives its excitation from the drop across the common cathode resistor  $R_k$ , while  $V_1$  is excited by  $e_i - e_k$ . The output is customarily taken from plate-to-plate.

#### Guideposts

Various guideposts in the analysis may be observed at the outset. When  $e_i = 0$ , the grids of  $V_1$  and  $V_2$  must have the same potential, and this potential is  $-e_k$ . Currents  $i_1$  and  $i_2$  will not necessarily be equal, however, unless  $R_{L1}$  and  $R_{L2}$  are equal. In general this will not be the case.

When  $e_i \neq 0$ , the grid of  $V_1$  is at a potential  $(e_i - e_k)$ , while the grid of  $V_2$  is at a potential  $-e_k$ . A positive-going voltage on the grid of  $V_1$  leads to a negative-going voltage on the grid of  $V_2$ .

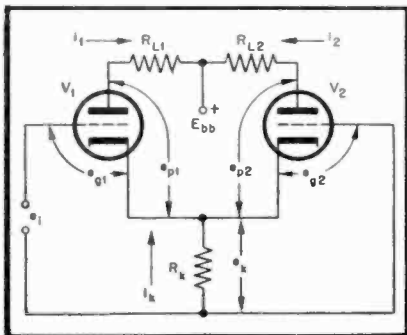

Figure 1

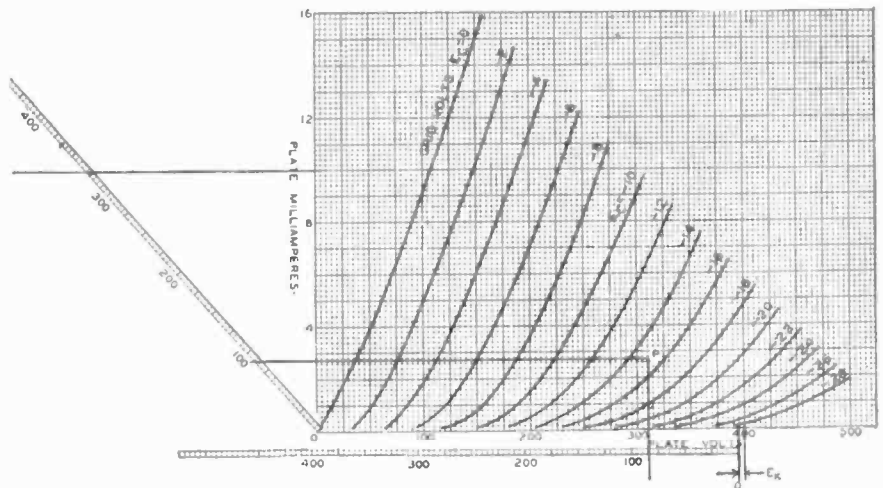

Figure 2

Published plate characteristics present voltages with respect to the cathode, and since the circuit of *Fig. 1* causes the lower end of  $R_k$  to be a voltage reference point, it becomes necessary to suitably modify the conventional procedure. The technique is well known for the case of a single-ended amplifier of the current-feedback type.\*

The analysis is started with some arbitrarily chosen value of cathode-resistor current  $I_k$ , and its resulting drop  $e_k$  through the resistance  $R_k$ . This drop  $e_k$  is evidently the voltage  $e_{g2}$ , the grid-cathode voltage impressed upon  $V_2$ . Unknown at this point are the components of  $I_k$ ,  $i_1$  and  $i_2$ , their resulting drops through  $R_{L1}$  and  $R_{L2}$ , and the required input voltage  $e_i$ .

The pattern of the analysis is as follows: Having chosen an arbitrary cathode resistance current  $I_k$  whose unknown components are  $i_1$  and  $i_2$ ,  $i_2$  is as yet unknown. But  $i_2$  can be found

because  $e_{g2}$  is known, and  $e_{p2} = E_{bb} - e_k - i_2 R_{L2}$ , as explained in greater detail below. Having found  $i_2$ ,  $i_1 = I_k - i_2$ , and the drop  $i_1 R_{L1}$ , can be computed. Then  $e_{p1} = E_{bb} - e_k - i_1 R_{L1}$ , and  $e_{g1}$  is found upon the characteristics at the intersection of  $e_{p1}$  and  $i_1$ . Knowing  $e_{g1} = e_i - e_k$ , it is now possible to compute  $e_i$ , and the problem is completely solved.

The end result of the analysis consists of two paths of operation upon the characteristics, each of which describes the behavior of an individual tube, and which together describe the plate-to-plate behavior when the individual outputs are added. The operating points are at  $e_i = 0$  on each path of operation:

#### Successive Approximations

To explain in greater detail how to proceed with the analysis, a slide rule is useful in making the most involved step: that of finding  $i_2$ . Subtract  $E_{bb}$  and  $e_k$ , and jot down the value. Set the index of the slide rule at the value of  $R_{L2}$  so

\*RADIO, March, 1946, p. 23

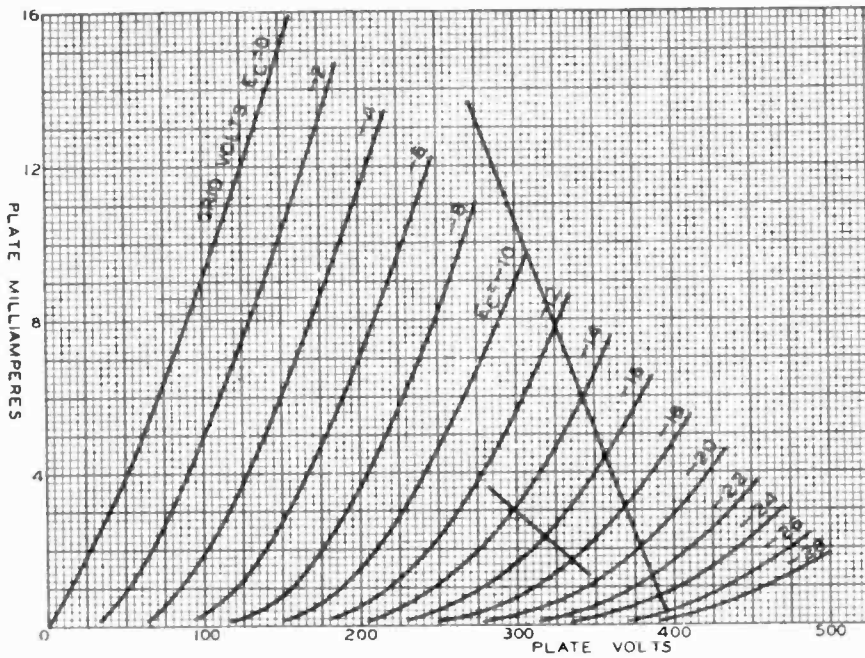

Figure 3

that all the drops of  $i_b R_k$  are apparent. Follow down the curve  $e_c = e_{ps}$ , until a likely looking value of  $e_{ps}$  is seen projected below; note the value of  $i_b$  at this point on the  $e_c$  curve, and glance at the slide rule, subtracting the slide rule drop from the jotted value. It will be too large or too small, indicating the direction and magnitude of error. Correct the chosen point accordingly, and check again. Three or four trials establish the point very closely, and subsequent points on the path of operation involve much less labor, since their general location follows from points already found.

In practical cathode-coupled grounded-grid amplifiers, a fixed bias is usually superposed upon the grids of  $V_1$  and  $V_2$  in order to control the operating point. This modifies the analysis only to the extent that when computing  $e_{ps}$ , it is recognized as having a value  $e_k - E_c$ , where  $E_c$  is the fixed bias. Likewise, in computing  $e_i$ , it is seen that  $e_i = e_{g1} + e_k - E_c$ .

**Complete Graphical Solution**

A complete graphical solution is shown in Fig. 2. Here  $E_{bb}$  is located, and the  $R_k$  drop computed for the assumed value of  $i_b$ . This is graphically subtracted from  $E_{bb}$  as shown.

Next, an  $e_b$  scale is laid off from right to left as shown, so that the value of  $E_{bb} - e_k - e_p$  can be read directly. Likewise, another  $e_b$  scale is laid off at an angle with respect to the  $i_b$  axis, as shown, to allow the  $i_b R_k$  drop to be read directly.

In other words, this set of linear scales solves the equation  $i_b R_k = E_{bb} - e_p - e_k$ , as is seen from Fig. 2. To locate a point on the load line of  $V_2$ , a right-angled device such as a draftsman's triangle, or even a sheet of paper, is slid along the characteristics, with the corner on the  $e_c = e_k$  curve, as shown. Maintaining the right-angled device square with the axes, the slide down the curve is stopped when the same value of voltage is attained on both auxiliary scales. The terminating point on the curve ( $P$ ) is a point on the load line of  $V_2$ . Other points are found in the same manner by choosing other values of  $i_b$ . The overall result of an analysis appears as shown in Fig. 3.

Since the corresponding points on the  $V_1$  load line are found by usual arithmetic calculations and points of coordinate intersection, the graphical treatment is applied only for the  $V_2$  determinations.

Thus, determining the paths of operation for  $V_1$  and  $V_2$  involves only slightly more labor than does analysis of the transformer-coupled push-pull amplifier. Moreover, the graphical analysis of the cathode-coupled grounded-grid circuit affords the only known method of computing actual performance.

Assuming that  $\mu$  and  $R_p$  are constant, as is done in algebraic solutions, necessarily leads to inexact conclusions. Using large charts of characteristics and making the graphical analysis carefully, it is reasonable to expect highly accurate results.

When the loadlines are drawn upon the plate characteristics, and the various values of input voltage noted at the proper points as explained under Fig. 2, an operating point ( $e_i = 0$ ) is determined upon each loadline. Travel along the loadlines for a given increment of input voltage takes place in opposite directions, and the projections of the grid swings upon the  $e_p$  axis yields the resulting plate-to-plate swing.

Gain of the circuit is of course found from the ratio of the plate-to-plate swing to the input voltage  $e_i$ . In general it will be found that the gain of the circuit is not much greater than that obtained for a single stage operating in the conventional manner. However, the advantage of the cathode-coupled circuit lies in the balanced output obtained as well as its improved performance under conditions of overdrive.

Graphical analysis of the circuit is interesting, and is capable of yielding information not otherwise obtainable with assumed linear parameters.

**SYMMETRICAL T AND H ATTENUATORS**

- Let  $Z$  = terminal impedance in ohms, pure resistance
- $\theta$  = attenuation in decibels multiplied by 0.1151
- $R_1$  = series arm resistance in ohms
- $R_3$  = shunt arm resistance in ohms

$$\text{Then } R_1 = Z \tanh \frac{\theta}{2}$$

$$R_3 = \frac{Z}{\sinh \theta}$$

Example 1:  $Z = 500$  ohms and attenuation = 5 db.  $R_1 = 140$  ohms.  $R_3 = 822$  ohms.

Example 2:  $Z = 500$  ohms and attenuation = 35 db.  $R_1 = 483$  ohms.  $R_3 = 17.8$  ohms.

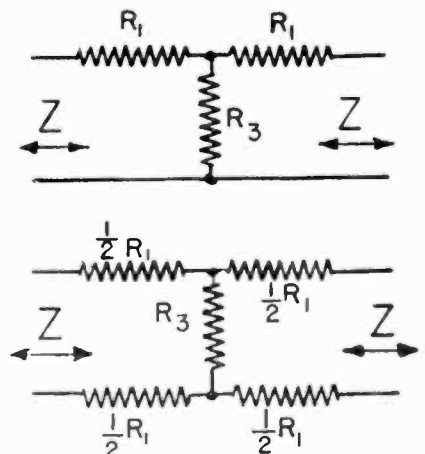



# RECENT RADIO INVENTIONS

These analyses of new patents in the radio and electronic fields describe the features of each idea and, where possible, show how they represent improvements over previous methods

## Thermionic Tube Circuit

★ A method of coupling to a cathode-follower vacuum tube through an artificial transmission line is described in a patent issued to Cyril E. McClellan recently. A cathode-follower circuit normally comprises a tube having a load impedance in the cathode connection which is common to both the input and output circuits of the tube. It is claimed that the method of the invention is superior to more usual arrangements because much lower voltage can be applied to the cathode-follower tube while yet obtaining voltages from the output connections that are at any desired level consistent only with the characteristics of the cathode-follower tube and the insulation of the artificial transmission line.

Reference to the accompanying diagram will aid in a further explanation of the invention. Suppose that the input signal is such that the plate of the amplifier tube swings over a 200 volt range. In an ordinary cathode-follower connection in which the grid of the cathode-follower tube is connected directly to the plate of the amplifier tube through a condenser alone so that a signal is applied between grid and ground, operation is possible only if the cathode voltage of the cathode-follower tube is not required to swing through a range of more than 200 volts above ground less whatever amount is necessary to keep the cathode-follower tube from being cut off.

The signal applied between the cathode and grid of the cathode-follower tube is that from the plate of the amplifier tube less whatever portion of that voltage is found across the output terminals of the cathode-follower. With the present invention this is not the case. The signal from the amplifier tube is carried through a transmission line and applied directly between the grid and cathode of the cathode-follower stage.

The artificial transmission line used in one form of the invention comprises two coils wound together on the central leg of a soft iron spool. The coils are arranged so that their coupling ap-

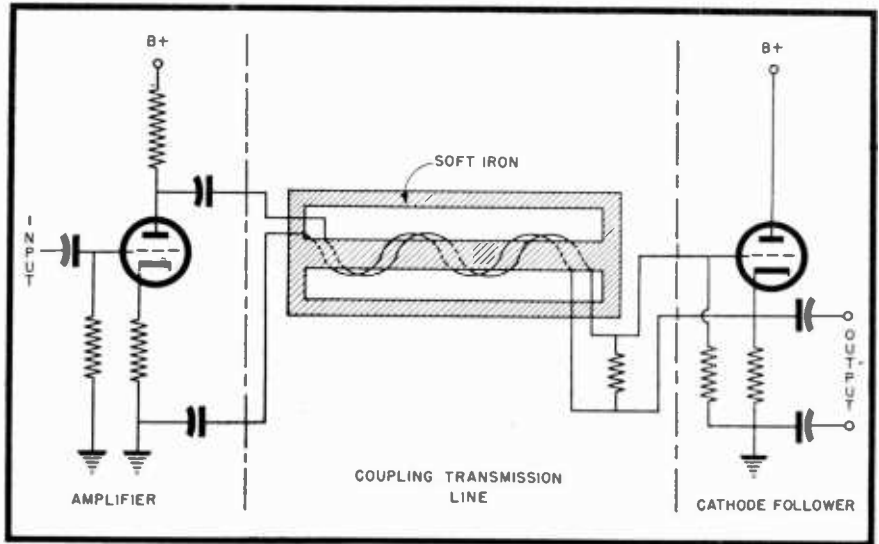

Patent No. 2,379,168

proaches unity. Because of this coupling and the nature of the transmission line element, the two connections to the cathode-follower tube are divorced from ground and hence can be applied directly between the grid and cathode.

The patent, number 2,379,168, is assigned to Westinghouse.

## Telegraph Signaling System

★ An improved method of carrier telegraphy is shown in a patent issued to Harry Nyquist recently. This system utilizes a frequency modulation technique to obtain simple and positive keying at high speed, yet maintaining most

[Continued on page 29]

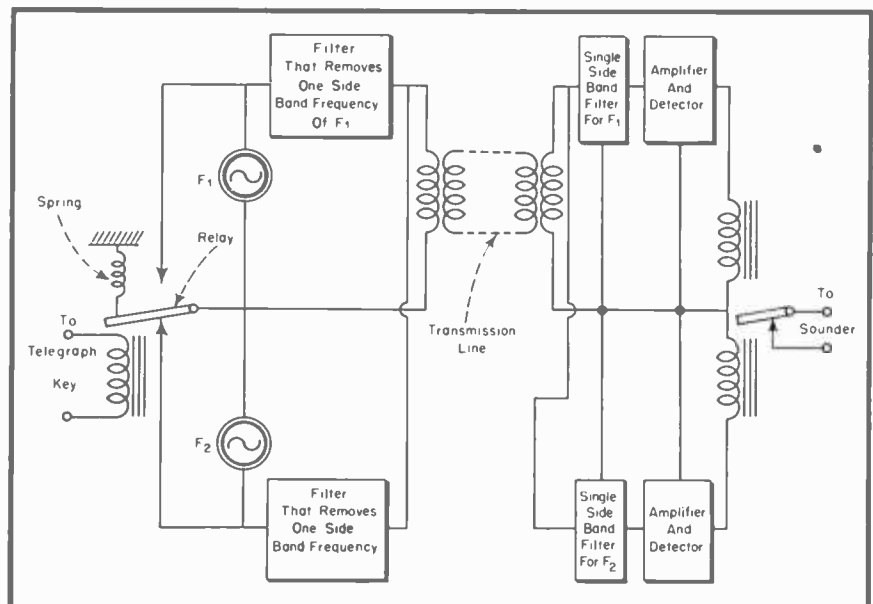

Patent No. 2,386,566

# New Products

## NEW RECORDER

Teelmo Machine & Tool Co., 200 Hudson St., New York 13, N. Y., announces a new low-cost instantaneous recording

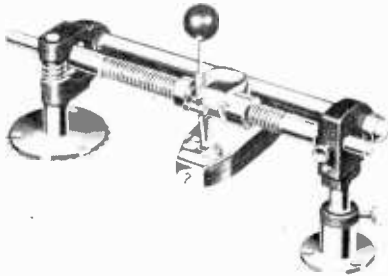

mechanism of the overhead type. This recorder is entirely new in design. Features are: Cutting needle angle adjustment, single lever for engaging feed screw and lowering cutting head and positive drive and gear which cannot be clogged by chips. The Teelmo-Crait recording mechanisms are adaptable to any height recording turntable. A thumbscrew allows for accurate adjustment of cutting depth. Its cutting pitch is 110 lines per inch, outside-in. The two models available permit recordings up to 16" diameter.

## HEAVY DUTY RECTIFIER

The newest of a series of improvements in the design and efficiency of selenium rectifiers have been incorporated in a heavy-duty stack developed by Federal Telephone and Radio Corp., Newark, N. J.

Federal's new selenium rectifier stack has double studs, center contact construction and 26-volt plates. Employing rectangular, square-cornered plates instead of the round type, the new stack is designed to mount either in a vertical position or in a horizontal position, thereby affording improved and unobstructed circulation of air for plate cooling. One of the new rectangular plates more than takes the place of two of the 4 3/8" diameter plates.

The advantages of parallel or series or series-parallel connection permits the formation of whatever combination is needed to supply the desired load.

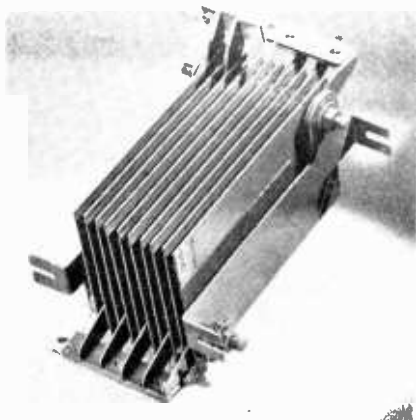

The vibration problem present in all rectifiers has been solved by the double mounts. The mounting of a-c and d-c bus connections also has been simplified. At the same time, better space utilization for heavy-duty current applications has been achieved.

One of the principal advantages of selenium rectifiers has always been the high allowable reverse voltage per plate. The new stack is composed of plates possessing higher reverse voltage than heretofore practicable from a commercial standpoint. These new plates are designed to withstand a rms voltage of 26 volts per plate, compared with the 18-volt plates previously supplied. With the new 26-v plates rectifier users have a tremendously greater factor of safety and allowable reverse voltage.

## NEW CRYSTAL UNIT

The Biley Electric Company, of Erie, Pennsylvania, announces the release of a new crystal unit, type VX2, specifically

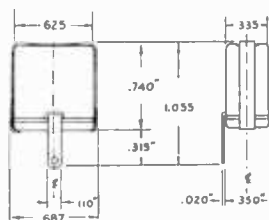

designed for use where space is at a premium. Type VX2 features a compact, gasket sealed assembly and solder lug connections replace the usual pin contacts. The unit is supplied at 3105 kc for use in private aircraft transmitters and is available at any specified frequency between 3000 kc and 1000 kc.

## MULTIPLE CONTACT CONNECTOR

A self-separating connector, newly developed by The Winchester Co., New York 17, N. Y., eliminates the prying and pulling required to disengage the ordinary multiple connector.

Molded of melamine plastic, the one-piece inserts reduce the danger of flash-over due to moisture and dust accumulations. Not only does this monoblock type construction permit easy removal of contacts, but it also makes the connector more rugged.

This connector can be supplied with a simple self-contained locking device for applications with very close space limitation. The necessity of any external clamping arrangement is thereby eliminated.

Multiple telescoping barriers serve to isolate contacts and increase both surface creepage and air gap between adjacent contacts. The connector is thus capable of being used at high potentials. Minimum air gap of 1/8 inch is maintained between all contacts. Contacts are designed for use with a maximum wire size of #16 AWG.

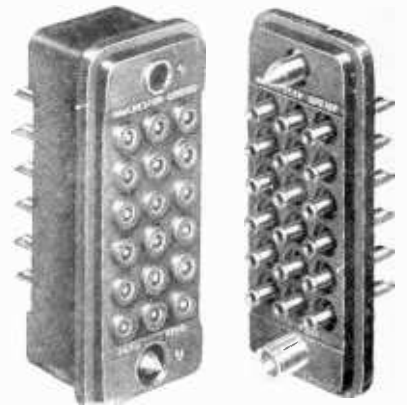

Descriptive bulletin 831-K is available; inquiries should be addressed to The Winchester Co., 6 East 46th St., New York 17, N. Y.

## FM ANTENNA

A new high efficiency antenna to meet the FM broadcaster's needs for maximum coverage of a given area has just been announced by the Western Electric Company. The new antenna, called the 54A Antenna, or "Cloverleaf," was designed by the Bell Telephone Laboratories to radiate horizontally polarized waves and to concentrate this radiated energy into a service area surrounding the transmitting station. The new antenna is engineered particularly for use by frequency modulation broadcast stations operating at new FCC assigned carrier frequencies between 88 and 108 megacycles and at power levels up to and including 50 kilowatts.

## WATER-COOLED CAPACITOR

Boosting kva ratings by a factor of five or more, or conversely, reducing the bulk for given ratings, the new Aerovox Series 1780 water-cooled mica capacitor is now available for extra-heavy-duty service such

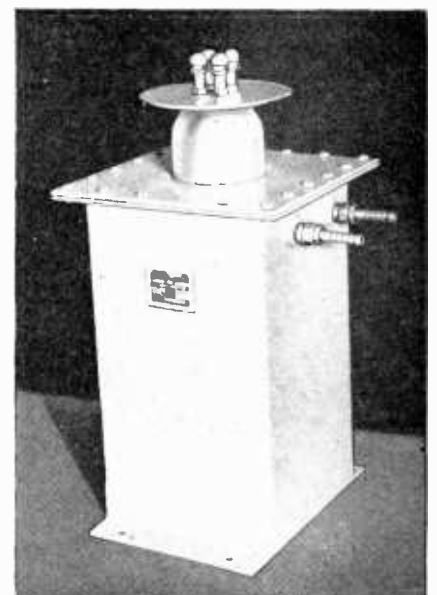

in high-power transmitters and induction furnaces.

The mica stacks are in an oil bath. Cooling coils in the oil bath provide for the efficient transfer of heat. Available in ratings up to 25,000 volts a.c. test, and in capacitances up to .01  $\mu$ fd., by Aerovox Corp. of New Bedford, Mass.

### RH-10 FREQUENCY CALIBRATOR

The Browning Laboratories has recently developed a new frequency calibrator Model RH-10 which allows full use to be made of the world's finest frequency standards which are transmitted from radio station WWV. The RH-10 is pre-tuned for 5 and 10 megacycles; either may be selected at will. Provisions are made for coupling secondary standards or other

r-f sources and comparing their fundamentals or harmonics with the standard frequencies transmitted by WWV. A cathode ray indicator permits frequency comparisons to be made to at least 1/10 cycle. A dual filter allows the selection of either the 440 or 4000-cycle modulation. This allows these frequencies to be employed as a primary standard.

The sensitivity of the RH-10 is better than 1/2 microvolt and the image rejection ratio is more than 50 db.

For further data, write Browning Laboratories, Inc., Winchester, Mass.

### H-F VTVM

The -hp- 410A high frequency vacuum tube voltmeter is a multi-purpose instru-

ment for laboratory, broadcast station, and production-line use. It measures a-c voltage from 20 cps to 700 mc, d-c voltage at 100 megohms input impedance, and resistance from 0.2 ohms to 500 megohms. For making a-c measurements a special low-capacity probe is employed which incorporates a new diode especially developed by Eimac for this instrument.

Input capacity is 1.3  $\mu$ f; input resistance is 6 megohms below 10 mc, less at higher frequencies due to dielectric losses. On a.c. the 410A reads 1 v. full scale to 300 v. full scale in 6 ranges. D-c measurements may be made from 1 v. full scale to 1000 v. full scale in 7 ranges; input impedance for d-c measurements is 100 megohms for all ranges. For making a-c measurements in low impedance circuits, the probe may be stored in a compartment in the instrument and connections made to binding posts on the front panel. Overloads will not damage the instrument.

### NEW E-V MIKE

A unique new combination crystal microphone and desk stand is announced by Electro-Voice, Inc., South Bend, Indiana.

Internal construction, together with high capacity crystal, provides smooth, wide-range response and exceptionally high output—gives fine reproduction of voice and music. Frequency response is substantially flat from 70 to 7,000 c.p.s.



Output level is 48 db below 1 volt/dyne/cm<sup>2</sup>, open circuit. Voltage developed by normal speech (10 dynes/cm<sup>2</sup>) is .0394 volt. Impedance is Hi-Z. Can be used with any standard amplifier employing high impedance input.

The Electro-Voice Comet, Model 902, may be used for group pick-up or for a single person.

For complete information, write to Electro-Voice, Inc., 1239 South Bend Ave., South Bend 24, Indiana.

### LEVER SWITCHES

A new line of lever-action switches has been announced by the P. R. Mallory & Co., Inc. These new switches are adapted to intercommunication, centralized radio, sound distribution and public-address equipment.

The lever-action switch offers a total of 26 circuit combinations, 13 each shorting and positive non-shorting, including two, three and four positions, all with positive indexing at 20 degrees between positions.

For complete information write for Engineering Data Folder, "Mallory Lever

## Ingenious New Technical Methods

To Help You with Your Reconversion Problems



## New, Simplified Drill Press Vise, Speeds Up Drilling, Spacing, Milling

Designed to be used with a drill press table having either parallel or radial slots, the New UNI-VISE drill press vise, with guide bar and protractor disc, speeds up and simplifies drilling, layout and spacing work in straight lines, radial or circular. With two movable jaws, vise has universal movement without swinging table or head of drill press to locate exact position of work. Operator thus adjusts work quickly for accurate registration.

**Guide Bar** facilitates drilling holes in a straight line. With a straight edge and a lineal scale on surface, it registers with lineal scale of vise. Protractor disc, for drilling holes accurately in a circle, has parallel slots registering with parallel slots in base of vise, and a removable means to pivot complete unit on table of drill press.

**Accurate work** can always best be done by attentive operators. That's why many factories urge workers to chew gum. The chewing action helps relieve monotony—helps keep workers alert, thus aiding them to do a better job with greater ease and safety. And workers can chew Wrigley's Spearmint Gum right on the job—even when hands are busy.

You can get complete information from Spiral Mfg. Corp., 3612-26 N. Kilbourn Ave., Chicago 41, Ill.

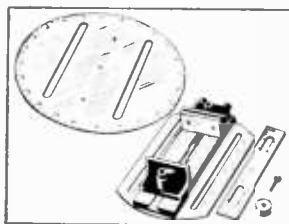

AA-83

# GROUP SUBSCRIBERS SAVE UP TO \$1.50 Each

**Form A Group Today!**

You and your co-workers can now save up to half the regular cost of a RADIO subscription by using the Group Plan. The more men in a Group the more each saves, up to 50%.

Present subscriptions may be RENEWED or EXTENDED as part of a group.

The combination of exclusive, fine and timely articles plus this low-rate subscription offer makes RADIO a must-have publication. So fellows, form a Group today and send it to—



## RADIO MAGAZINES, INC

342 MADISON AVENUE NEW YORK 17, N. Y.

TEAR OUT—MAIL TODAY!

RADIO MAGAZINES, INC.  
342 Madison Ave., New York 17, N. Y.

Kindly enter the following subscription to RADIO Magazine. Remittance of \$..... is enclosed. (1 to 6 subscriptions may be ordered on this form).

- One 1-year subscription . . . . . \$3.00
- Two 1-year subscriptions . . . . . \$5.00
- Three 1-year subscriptions . . . . . \$6.00
- Four 1-year subscriptions . . . . . \$7.00
- Five 1-year subscriptions . . . . . \$8.00

Groups of 6 or more subscriptions in the U.S.A. and Canada will be accepted at the rate of \$1.50 each. For Foreign groups add \$.50 to each subscription ordered.

PLEASE PRINT

Name .....

Address .....

Position ..... Company .....

Name .....

Address .....

Position ..... Company .....

Name .....

Address .....

Position ..... Company .....

Name .....

Address .....

Position ..... Company .....

Name .....

Address .....

Position ..... Company .....

NOTE: If you do not wish to tear out this order blank, print or type a list giving each subscriber's name, address, employer's name and their respective positions. Mail it in today!



Action Switches, Series 5000 and 6000." Address requests to P. R. Mallory & Co., Inc., 3029 Washington St., Indianapolis 6, Ind.

### NEW PILOT LIGHT

This series of pilot light assemblies is designed on the light-shield principle—to direct a beam of light within a rotation of 360 degrees. A turn of the knurled head directs the light on to any localized spot, at any desired angle.

Complete descriptive literature can be obtained from the manufacturer, Dial Light Co. of America, Inc., 900 Broadway, New York 3, N. Y.

### DUAL POWER SUPPLY

Two independent, regulated power sources are combined in the CML 1115 Dual Power Supply.

The "B" supply furnishes a continuously variable d-c voltage from 180 to 300 volts, at 70 ma., with a maximum ripple of less than 25 mv. The negative side of the supply is isolated from the chassis.



so that the +B may be grounded if it is desired to use the supply as a source of grid bias for tubes which draw heavy grid current.

A continuously variable d-c voltage from 0 to 75 volts with less than 7 mv ripple is furnished by the "C" supply.

Descriptive bulletin available; inquiries should be directed to Communication Measurements Laboratory, 120 Greenwich St., New York, N. Y.

### R-F PROBE

A new r-f probe for functional testing of high frequency power circuits is manufactured by Radio Frequency Laboratories, Inc., Boonton, N. J. When the probe tip is subjected to an r-f field, a proportionate r-f current is capacitively induced, rectified and indicated on Weston 506 meter.

Many uses include the quick detection of standing waves, shielding power leads, r-f choke efficiency, and circuit tracing for r-f in all radio frequency equipment and associated components, without affecting operation of the circuit.

### 1L65 NEW PENTODE

A new semi-remote cut-off pentode amplifier, designed for efficient operation in portable battery and a-c/d-c receivers where plate supply may drop as low as 45 volts, has been announced by the radio tube division of Sylvania Electric Products, Inc., 500 Fifth Avenue, New York 18, N. Y. Remote cut-off characteristic of the new type 1L65 tube makes it better suited to a-v-c circuits than type 1L65.

Efficient operation with 45 volt plate supply makes it complementary to types 1L15, 1L16 and 1L14 for receiver circuit applications, since they also provide good operation under the same low plate voltage condition.

The tube filament is rated at 1.6 volts maximum for battery operation and has



a design center of 1.3 volts for a-c/d-c operation. Maximum direct interelectrode capacitances, when 1 5/16" diameter RMA standard M8-308 shield is connected to the negative side of the filament, are: grid to plate .007 max. mmf; input 3.2 mmf; and output 7.0 mmf.

Typical operating conditions and characteristics with 45 volt plate supply in class A1 amplifier service, with suppressor grid connected to negative filament at socket, are:

Filament voltage, d-c	0.05 ampere
Filament current	1.4 v.
Plate voltage	45 v.
Screen grid voltage	45 v.
Control grid voltage	0 v.
Control grid resistance	2.0 meg.
Plate current	1.5 ma
Screen grid current	.45 ma
Mutual conductance	800 micromhos
Plate resistance, approx.	0.35 megohm

Control grid voltage for a Gm of approximately 10 micromhos is -9 volts. The grid leak is recommended to supply required operating bias in addition to that obtained from the a-v-c circuit.

### NEW CHOKES

Two new chokes, the R-100S in the 2 1/2 mh size and the R-300S in the 1 mh size, have been placed on the market by the National Company, Inc. of Malden, Mass.

The R-100S is a continuous universal winding in four sections wound on an isolantite form for 6-32 screw mounting in any position. Each end of the winding terminates at cotter-pins, easily accessible for soldered connections. The overall dimensions are 2" x 11/16," the current rating is 125 ma, and the direct current resistance is 50 ohms.

The R-300S r-f choke has an isolantite form and is wound in a continuous universal winding in three sections. Characteristics include a d-c resistance of 10 ohms, a current rating of 300 ma, and a distributed capacity of 1 mmf. The overall dimensions are 2" x 11/16".

## SPEEDY OPERATION BY FACTORY PERSONNEL

### with a QX CHECKER

TYPE 110-A



### The Production Line

### Test and Measuring Instrument for Radio Components

This production test instrument is specifically designed to rapidly and accurately compare relative loss and reactance in one operation and with a single setting. Speedy operation results from the fact that the

deviation of both the reactance and resistance values of any R.F. component are simultaneously indicated when that component is resonated in a tuned circuit which has been previously adjusted against a known standard.

FREQUENCY RANGE: 100 kc to 25 mc using plug-in coils. RANGE OF INDUCTANCE COMPARISON: 10 microhenries to 10 millihenries. RANGE OF CAPACITANCE COMPARISON: Approximately 2 mmf to 1000 mmf. ACCURACY OF INDUCTANCE CHECK: Approximately 0.2 percent.

WRITE FOR CATALOG "C"

**BOONTON RADIO**

BOONTON · N · J · U · S · A ·



DESIGNERS AND MANUFACTURERS OF THE "Q" METER . . . QX-CHECKER . . . FREQUENCY MODULATED SIGNAL GENERATOR . . . BEAT FREQUENCY GENERATOR . . . AND OTHER DIRECT READING TEST INSTRUMENTS

**NEW CONCORD BULLETIN**

News of interest to the radio field is contained in Concord Radio Corporation's announcement of a brand-new bulletin and supplement to Concord's complete catalog which was issued recently. The new bulletin-supplement features new merchandise available for immediate shipment from warehouses in Chicago and Atlanta. The offerings include hundreds of hard-to-find, long-sought items—and also many standard items at money-saving bargain prices.

A free copy of the new bulletin may be obtained by writing the Concord Radio Corp. at 901 W. Jackson Blvd., Chicago 7, Ill.

**FTR REFERENCE BOOK**

"Reference Data for Radio Engineers," radio handbook published by Federal Telephone and Radio Corp. has been reissued in revised and enlarged form. This second edition, like its predecessor, has been presented as an aid in the fields of research, development, production and education.

Over 50,000 copies of the first edition of "Reference Data for Radio Engineers" were sold. The second edition retains all the material that proved highly useful and popular in the first edition, with much additional data. The second edition has been expanded to 336 pages and now has over 400 illustrations, more than twice as many as in the original edition. The format is completely new and modern and a complete subject index has been added.

New chapters on transformers and on room acoustics have been added. The room acoustics chapter was specially written for the book by Edward J. Content, well known consulting engineer on numerous important acoustical installations and a recognized authority on the subject. Some of the original chapters have been rearranged and in many instances much new material has been added.

The new book is priced at \$2.00 a copy, or \$1.00 a copy when ordered for bulk shipment to a single address in quantities of 12 or more. All queries concerning "Reference Data for Radio Engineers" should be addressed to Publication Department, Federal Telephone and Radio Corp., 67 Broad St., New York 4, N. Y.

**RECTIFIER TUBES**

Technical data on thyratrons, mercury vapor and high-vacuum rectifiers, as well as multi-grid thyratrons, is presented in a two-color 24-page catalog issued by Chatham Electronics, 475 Washington St., Newark 2, N. J. The material is attractively bound and printed.

**CARRIER-SHIFT TRANSMITTERS**

A wide cross-section of frequency-shift transmitting equipment is described and illustrated in a loose-leaf offset-printed bulletin offered on request by Press Wireless Mfg. Corp., 38-01 35th Ave., Long Island City, N. Y. Units included in the bulletin include a 50-kw 4-21 mc transmitter capable of keying at 400 wpm, 15-kw amplitude modulator, several smaller telephone-telegraph transmitters from 400 watts upward, frequency-shift keyers,

**SWEDEN**

Well established and highly reputable firm of importers, with large sales staff, desires contact with manufacturers and suppliers of:

- Portable battery radio receivers
- Batteries for such sets
- Radio tubes of all types for receivers
- Electrolytic condensers, rheostats, replacement parts
- Record-changers, mikes and pickups
- Novelty items and radio accessories
- Bakelite and other plastics

We want to import on firm account with sole selling rights for Scandinavia.

(References: Swedish Legation, Com'l Dep't., Washington; Scandinavianiska Banken, Svenska Handelsbanken, Soderstalje, Sweden)

**HARRY ANDERSON — Södertalje — SWEDEN**

*Lafayette*

**RADIO BARGAIN BUYS**

**TUBES**

- EIMAC 304th medium-mu triode can be used as modulator, oscillator or amplifier. Good up to 10 meters . . . \$9.95
- 327A . . . 3.95
- 807 . . . 1.49
- 829, 829B . . . 4.95
- 813 xmitting tube, 360 w. input Beam Power Amplifier, requires no neutralization . . . 9.95
- WESTINGHOUSE KLYSTRON 417A . . . 2.95
- 954 . . . .69
- 955 . . . .69
- 956 . . . .69

**RECEIVER**

BC-406 is a 15 tube, 205 mc. superhet that's a natural for conversion to the 10, 5 and two meter bands . . . **19.95**

**SPECIAL**

SONAR F-M EXCITER Model XE-10 conveniently and economically adapts any cw or phone xmitter for F-M x-mission. **39.45**

**FILTER CONDENSERS, OIL FILLED**

- XPS498 2 mfd. 600 v. round. 2 7/8" x 1 1/2" . . . .59
- XPS499 4 mfd. 600 v round. 4 1/2" x 1 1/2" . . . .1.19
- HR102 6 mfd. 600 v. 4 3/4" x 2 1/2" x 1 1/4" . . . .1.35
- HR104 4 mfd. 1000 v. 4 3/4" x 2 1/2" x 1 1/4" . . . .1.49
- HR103 1 mfd. 2000 v. 4 3/4" x 2 1/2" x 1 1/4" . . . .1.49
- HR105 3 mfd. 2000 v. 4 3/4" x 3 3/4" x 1 1/4" . . . .2.95

**25TH ANNIVERSARY CATALOG**

**FREE!**

It will take you a solid week to chaw over the thousands of items in the new giant-sized Lafayette catalog. And we don't piddle with pennies; these are dollar-saving values. Get on our mailing list right now; use the coupon below.



Frank Lester, W2AMJ, is back in charge of Lafayette's Ham Division — ready to answer questions and pass the time of day with you. Ask for him when you stop in or write.

**LAFAYETTE RADIO**

LAFAYETTE RADIO, Dept. BH-6  
100 Sixth Avenue, New York 13, N. Y.  
PLEASE SEND ME THE FOLLOWING:

Quan.	No.	Price (each)	Quan.	No.	Price (each)
.....	.....	.....	.....	.....	.....
.....	.....	.....	.....	.....	.....

(List additional items on separate sheet and attach to coupon)  
Enclosed find \$.....  check  M.O.;  send C.O.D.  
 Please send me your new giant-sized catalog FREE of charge.

Name.....  
Address.....  
City..... Zone..... State.....

**RADIO WIRE TELEVISION, INC.**

100 Sixth Ave.  
New York 13, N. Y.

110 Federal St.  
Boston 10, Mass.

24 Central Ave.  
Newark 2, N. J.

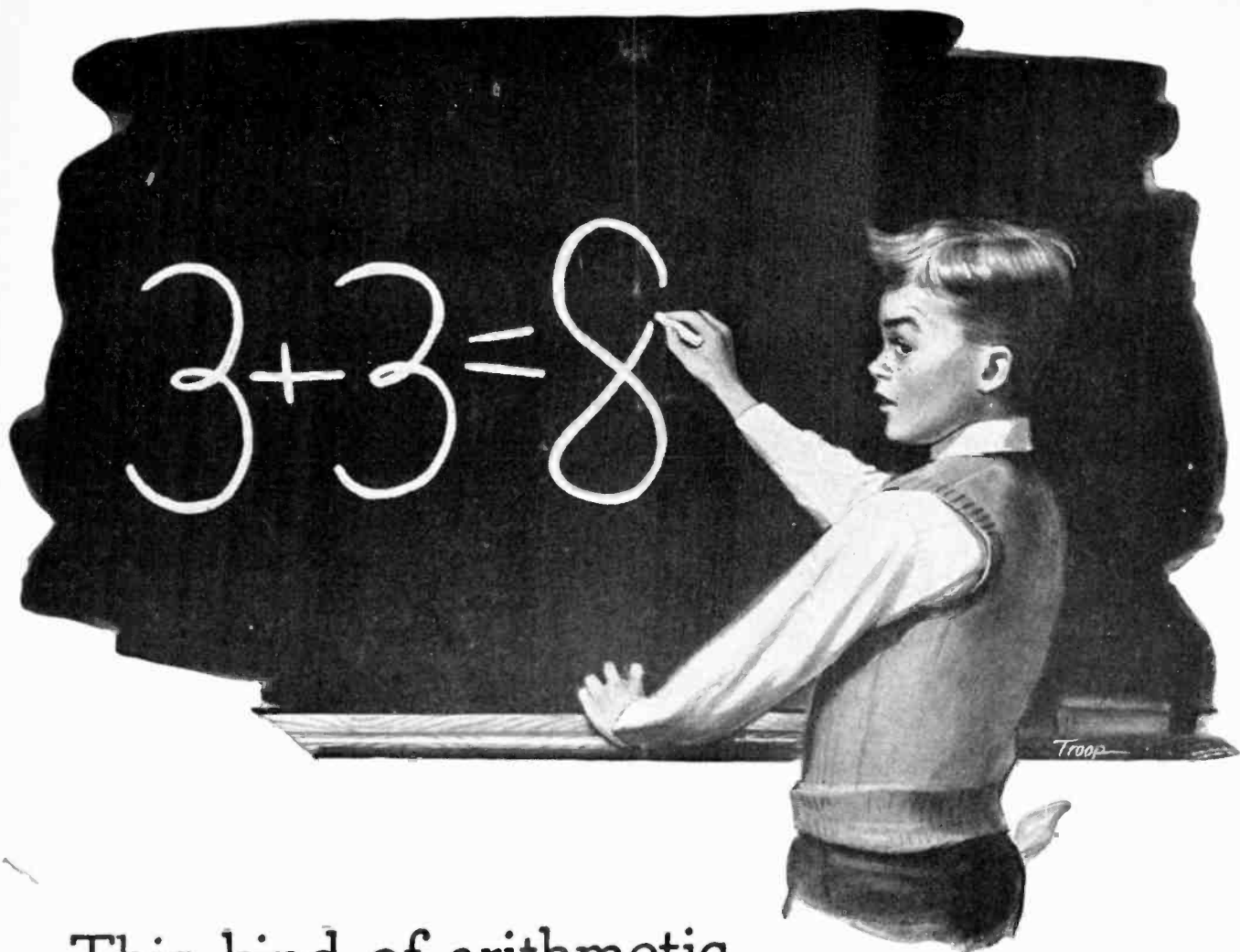

## This kind of arithmetic may put Johnny through college

Here's how it works out:

**\$3 put into U. S. Savings Bonds today will  
bring back \$4 in 10 years.**

**Another \$3 will bring back another \$4.**

So it's quite right to figure that 3 plus 3 equals  
8 . . . or 30 plus 30 equals 80 . . . or 300 plus  
300 equals 800!

It will . . . in U. S. Savings Bonds. And those

bonds may very well be the means of helping  
you educate your children as you'd like to have  
them educated.

So keep on buying Savings Bonds—available  
at banks and post offices. Or the way that mil-  
lions have found easiest and surest—through  
Payroll Savings. Hold on to all you've bought.

You'll be mighty glad you did . . . 10 years  
from now!

**SAVE THE EASY WAY... BUY YOUR BONDS THROUGH PAYROLL SAVINGS**

*Contributed by this magazine in cooperation  
with the Magazine Publishers of America as a public service*



monitor, keyer coupler, compressor amplifier and preamplifiers for voice transmission, line amplifiers, triple diversity receivers, diversity tone keyers, polar d-c driver, tape scanner, recorder, and a complete line of photo-fax units.

An interesting insert discusses the technical features of r-f carrier shift, which is described in detail in RADIO.

The bulletin is handsomely illustrated and is a valuable addition to any technical library.

### MIDGET RELAYS

Coil and contact data, contact arrangement diagrams, and dimension sketches of midget metal-base relays are presented in a new four-page booklet issued by Ward Leonard Electric Co., 31 South St., Mt. Vernon, N. Y.

### SPECIAL-PURPOSE SPEAKERS

Loudspeakers for railroad and marine, submergence, industrial, and field applications are described and illustrated in a 24-page two-color catalog offered by University Loudspeakers, Inc., 225 Varick St., New York 14, N. Y. Speakers are listed with ranges up to two miles, explosion-proof designs, and models which will function in live steam at 90-pounds pressure.

## INVENTIONS

[from page 22]

of the band width economy obtained with simple side-band transmission.

If it is desired to send simultaneously several telegraph messages over a single transmission link, it may be done by sending each by means of symbols formed by interrupting an alternating current of a characteristic frequency. At the receiving end the various frequencies are separated by filters, then separately rectified and made to operate simultaneously independent sounders with the individual messages. The number of messages which can be handled depends upon the frequency band width required by each channel. This width in turn is determined by the side band frequencies generated at the moment the carrier frequency is interrupted or restored. As in any amplitude modulation, these frequencies must be transmitted in order to reproduce the abrupt on-and-off character desired at the receiver. But it is possible to eliminate half the side bands without harming the intelligence and this is normally done. A filter, placed in the transmitter at a point beyond the keying point, is arranged to pass only the carrier frequency and single side band.

In practice, practical side-band filters introduce a 90° phase shift of a part of the side band energy, and that this phase-shifted component, which is present only during interruption or reconnection of the carrier frequency, tends



## For the Man Who Takes Pride in His Work

FM and Television Band Coverage on Strong Harmonics. Strong Fundamentals to 50 MC.

Another member of the Triplet Square Line of matched units this signal generator has features normally found only in "custom priced" laboratory models.

**FREQUENCY COVERAGE**—Continuous and overlapping 75 KC to 50 MC. Six bands. All fundamentals. **TURRETTYPE COIL ASSEMBLY**—Six-position turret type coil switching with complete shielding. Coil assembly rotates inside a copper-plated steel shield. **ATTENUATION**—Individually shielded and adjustable, by fine and coarse controls, to zero for all practical purposes. **STABILITY**—Greatly increased by use of air trimmer capacitors, electron coupled oscillator circuit and permeability adjusted coils. **INTERNAL MODULATION**—Approximately 30% at 400 cycles. **POWER SUPPLY**—115 volts, 50-60 cycles AC. Voltage regulated for increased oscillator stability.

**CASE**—Heavy metal with tan and brown hammered enamel finish.



**MODEL 2432  
SIGNAL GENERATOR**

**Triplet**  
ELECTRICAL INSTRUMENT CO.  
BLUFFTON OHIO



**Immediate SHIPMENT!**  
**RADIO PARTS  
ELECTRONIC EQUIPMENT**

**New CONCORD Bulletin-FREE**  
Hundreds of Bargains—Scores of New Items

**READY NOW!** 8 giant-size pages packed with long-awaited Radio and Electronic Parts, Supplies and Equipment—new merchandise, just received—now in stock for IMMEDIATE SHIPMENT! See hundreds of items for every Radio and Electronic need—for building, repair, maintenance—for engineer, manufacturer, service man, amateur—top-quality, standard-made parts—including Condensers, Resistors, Meters, Controls, Switches, Relays, Transformers, Test Equipment, Tools, Amplifiers, Record Players, Record Changers, and many other new and scarce items—scores of them at money-saving bargain prices—all ready for shipment at once from CHICAGO or

ATLANTA. Mail coupon below TODAY for your FREE copy of new CONCORD Bulletin.

### Did You Get CONCORD'S NEW COMPLETE CATALOG?

Showing the latest and greatest selection of guaranteed quality Radio Sets, Phono-Radios, Radio Parts, Supplies, Equipment, Amateur Gear, Kits—plus the new Multi-amp Add-A-Unit Amplifiers—exclusive with CONCORD. If you do not have the new COMPLETE CONCORD Catalog, check coupon below.



**CONCORD**  
**RADIO CORPORATION**  
LAFAYETTE RADIO CORPORATION  
CHICAGO 7 ATLANTA 3  
301 W. Jackson Blvd. 265 Peachtree Street

CONCORD RADIO CORPORATION  
901 W. Jackson Blvd. Dept. Chicago 7, Ill.  
Please rush my FREE COPY of the new Concord Bulletin of Radio Parts.  
 (Check if you also want new Complete Concord Radio Catalog)  
Name .....  
Address .....  
City ..... State .....



# HOPP Plastic RADIO DIALS

DIAL WINDOWS, NAME PLATES, GAUGES, CALCULATORS, SCALES, CHARTS, ETC.

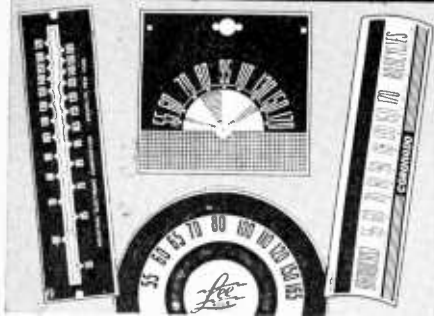

PLASTIC RADIO DIALS have endless possibilities in design, size, shape and color combination. Attractive and durable, our radio dials, windows and scales are preferred by many leading Radio manufacturers.

Not only for dials, but for numerous other electronic and electrical applications, Laminated Plastics are preferable.

Consult with our artists and engineers regarding applications for your particular purpose. Or... send us your blue prints or samples for quotation.

**THE HOPP PRESS, INC.**  
460 W. 34th STREET, NEW YORK 1, N. Y.  
ESTABLISHED 1893

## 18 YEARS IN RADIO

Get This New Catalog  
By This Old Firm

Latest developments in radio and electronic parts and devices, newest ham gear, gadgets to delight the heart of the experimenter, bargains in war surplus supplies.



It's  
**FREE**  
To You

- Buy from B-A
- Save Time
- Save Money
- Get the Newest
- Deal with This Old House

### MAIL COUPON TODAY

Don't delay, get your copy of this book.

BURSTEIN-APPLEBEE CO.,  
1012 McGee, Kansas City 6, Mo.

Send me FREE new catalog, RADIO

\* AM \_\_\_\_\_  
STATE CONNECTION IN INDUSTRY

NAME \_\_\_\_\_

ADDRESS \_\_\_\_\_

TOWN \_\_\_\_\_ STATE \_\_\_\_\_



to affect adversely the response of the receiving sounders. The present invention seeks to avoid this difficulty by using two carrier frequencies for each message channel instead of one. The interruption of one carrier to form a space between the code symbols connects another carrier of a different frequency to the line in its place and the unwanted phase-shifted side-band components are thus caused to compensate for each other.

In the accompanying drawing, the two frequencies  $F_1$  and  $F_2$  are generally close together in frequency so as to use as little spectrum space as possible. Only one transmitting equipment and the corresponding receiving station are shown, although several such pairs would normally be connected in parallel to the same transmission line.

The patent, No. 2,386,566, is assigned to the Bell Telephone Laboratories.

## FREQUENCY SHIFT

[from page 17]

principles to operating actualities received great impetus during the war. This was due in part to the shortage of trained Morse code operators, which made automatic printing essential to speedy handling of the vast amount of traffic. Frequency-shift techniques proved entirely successful for operating automatic printers on difficult, long range, radio circuits where other methods failed.

Most commercial communications companies are now carrying on frequency-shift development programs. These promise to produce greatly improved techniques in this field which will eventually convert the majority of all radio communications to an automatic printing basis.

## TRAVELING WAVE

[from page 13]

extend on to the right for many cycles. In the other two drawings, the same situation is shown with the sine waves shifted somewhat to the right as they will be at slightly later times. If one thinks of the first sketch of Fig. 1 as gradually changing into the second sketch and then into the third he obtains a picture of the motion of the traveling wave.

Now a very important factor in the traveling wave tube generator of r-f energy is that the electrons move somewhat faster than the wave. The tolerance on how much faster is quite broad and is quoted as being one of the important advantages of this type of tube. Nevertheless, the excess speed is important and is the reason that even

## A Warehouse full of U. S. GOV'T SURPLUS ELECTRONIC EQUIPMENT

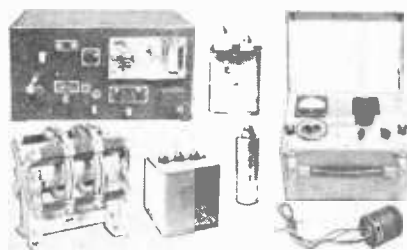

## Special -- WOOD TRIPODS

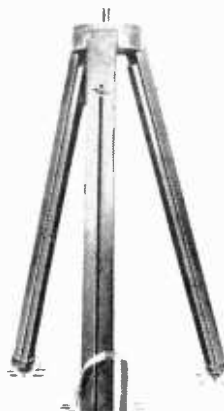

Olive Drab Finish. 45" to 84". Will carry up to 50 lbs.

Originally designed for mounting speaker trumpets. Can be used for mounting...

FLOODLIGHTS  
CAMERAS  
FANS, ETC.

Quantity: 1,200 pieces @ \$2.50 each.

Minimum quantity available: 100. Individually packed. Weight 25 pounds.

Inquiries invited from Jobbers, Distributors, Exporters, Priority Purchases, etc.

## ELECTRONIC CORP. OF AMERICA

Central General Agents for War Assets Administration  
353 W. 48th St. New York 19, N. Y.

though electrons are fed into the tube at all phase relations to the traveling wave, there is still a selective action which causes much more energy to be transferred from the beam to the r-f field than vice versa. A qualitative explanation of this may be given in reference to *Fig. 4*.

Consider an electron like the one marked *A* in *Fig. 1*. This electron has happened to enter the tube at a time when it travels along with a portion of the traveling wave that causes acceleration. It is therefore a disadvantageous electron as far as the desired action of the tube is concerned. It gets ahead of the wave, however, for two reasons, because it has a larger initial velocity and, less important, because it is accelerated. Thus as is shown in the successive sketches of *Fig. 1*, it rather quickly catches up to at least a neutral point like the one in the last drawing and then no longer absorbs energy from the r-f field.

On the other hand, an electron like the one marked *B* in *Fig. 1*, which happens to enter the tube with a phase relation that calls for deceleration, will tend to stay in the decelerating region it enters. It may for some time move faster than the traveling wave because of its initial superior velocity. This is shown in the second sketch of *Fig. 1*. It may later have lost so much energy as actually to start to get behind again as is shown in the last sketch.

Electrons may also move from an accelerating region into a decelerating region. Consider for example an electron like the one marked *C* in *Fig. 1*. Starting in an accelerating field, its initial superior velocity may carry it over into a decelerating portion of the wave. There, it gave up energy to the r-f field.

### Electron and Wave Velocities

In coaxial line, traveling waves are propagated with the speed of light and there is of course no possibility of getting the electrons to go faster than that. Not only do very high velocities call for inconveniently high voltages under any circumstances, but also the speed of light is known to be greater than any physical body can possibly travel. It would take an infinite amount of energy to make even a particle as small as an electron go that fast. As such a particle is accelerated more and more by a voltage, it is found that it refuses to go much faster but simply gets heavier instead. This, incidentally, is an interesting point in conjunction with electron accelerator tubes because it means that the traveling wave velocity need not change much progressively to keep up with increased electron energy once

the speed of light is approached.

In wave guides, unlike coaxial line, the velocity of propagation is slower than the velocity of light. Furthermore it is to some extent controllable by variation in the wave guide size. Unfortunately, however, it is always a large percentage of the velocity of light and there is no possibility of decreasing it

enough to allow electrons from convenient electron guns to have greater velocity. Only by the use of a special arrangement can the desired propagation velocity be obtained.

*Figure 5* illustrates a way in which a traveling wave may be made to have a suitable form and yet travel with a speed as small as a tenth to a twentieth

## AVAILABLE NOW—

**Excellent Chicago space for radio or television station, recording or audition studios, ad or art agency, any firm needing unusual 2-fl. space**

Unusual circumstances make immediately available 8,064 sq. ft. on top two floors of nationally known, modern Chicago office building. Space now laid out with private offices and studio workrooms. One 2-story acoustically treated studio is 38'x46'. Exceptionally attractive opportunity for radio or television station, recording or audition studios, advertising or art agency, commercial photographer—any firm requiring unusual space. Rare chance to acquire prestige downtown location, close to all city and suburban transportation, at a rental which invites immediate attention.

**Principals or Agents Address Box 35  
RADIO MAGAZINES, INC.  
342 Madison Ave., New York 17, N. Y.**



# CQ

**The Radio Amateurs' Journal**



If you are or intend to be a "ham" — or if your work entails radio communications — you'll like CQ. Subscribe now!

12 issues ..... \$2.50  
24 issues ..... 4.00  
36 issues ..... 5.00

*In U. S. A. & Possessions*  
Elsewhere \$3.50 per year

Tear Off and Mail

"CQ" is sold on newsstands

**CQ-RADIO MAGAZINES, INC.  
342 MADISON AVE., NEW YORK 17, N. Y.**

Sirs: Here is my  check (or  money order) for \$ ..... Send me ..... issues of CQ.

Name .....

Address .....

City ..... State .....

Occupation ..... Call Letters.....

*World Radio Leads in*



**SAVINGS**

**40 WATTS INPUT — WRL GLOBE TROTTER TRANSMITTER KIT**

Complete including all parts, chassis panel, streamlined cabinet, less tubes coils, and meter, Cat. No. 70-300... **\$59.95**  
 Cat. No. 70-312 Kit same as above wired by or engineers ..... \$75.00  
 All necessary accessories ..... \$13.85 Extra

Here is the latest most outstanding transmitter value on the market today. Capable of 40 Watts input on C.W. and 25 Watts input on phone on all bands from 1500 KC through 28 Megacycles. Incorporates Tritet Oscillator using a 20 meter X-tal, three bands; 10, 20, and 80 meters; two power supplies.

**FREE! RADIO PARTS FLYER** SEND FOR YOUR COPY TODAY

Page after page of real savings in radio, electronic and general merchandise.

Giant Radio Reference Map **15c** Tube Base Calculator .... **25c**



Formerly Wholesale Radio Laboratories  
 Address Dept. R-8, Council Bluffs, Iowa

**BOOKS FOR THE ENGINEER**

**UNDERSTANDING MICROWAVES**

(Chapter Heads)

The Ultra High Frequency Concept Stationery Charge and its Field • Magnetostatics • Alternating Current and Lumped Constants • Transmission Lines Paynting's Vector and Maxwell's Equations • Waveguides • Resonant Cavities • Antennas • Microwave Oscillators • Radar and Communication • Section Two is devoted to descriptions of Microwave Terms, Ideas and Theorems. Index.

400 PAGES PRICE \$6.00

**A-C CALCULATION CHARTS**

Student engineers will find this book invaluable. Simplifies and speeds work. Covers all AC calculations from 10 cycles to 1000 megacycles.

160 PAGES PRICE \$7.50

**JOHN F. RIDER, Publisher, Inc.**

404 FOURTH AVENUE, NEW YORK 16, N. Y.  
 EXPORT DIV. ROCKE-INTERNATIONAL ELEC. CORP.  
 13 E. 40TH STREET, NEW YORK CITY CABLE ARLAB

**ADVERTISING INDEX**

ADVERTISER	PAGE
Adams & Westlake Co. ....	9
American Phenolic Corp. .Cover	2
Anderson, Harry .....	27
Bell Telephone Labs .....	4, 5
Boonton Radio Corp. ....	26
Burstein-Applebee .....	30
Capitol Radio Engineering Inst. ....	8
Concord Radio Corp. ....	29
Eitel-McCallough, Inc. ....	7
Electronic Corp. of America .	30
Federal Tel. & Radio Corp. Cover	3
Hopp Press, The .....	30
Jensen Radio Manufacturing Co. ....	2
Racon Electric Co. ....	10
Radio and Television Supply Co. ....	32
Radio Wire Television .....	27
Rex Rheostat Co. ....	32
Rider, John F. Publisher, Inc.	32
Ruby Chemical Co. ....	32
Sylvania Electric Products, Inc. ....	Cover 3
Triplett Electrical Instr. Co. .	29
Western Electric Co. ....	4, 5
World Radio Laboratories ...	32
Wrigley Jr., Co., Wm. ....	24

**ADDRESS CHANGES—**

Subscribers to RADIO should notify our Circulation Dept. at least 3 weeks in advance regarding any change in address. The Post Office Dept. does not forward magazines sent to a wrong address unless you pay additional postage. We cannot duplicate copies of RADIO sent to your old address.

RADIO Circulation Dept.  
**Radio Magazines Inc.**  
 342 Madison Ave., New York 17, N.Y.

of the velocity of light. The instantaneous picture of the electric field is very similar to that of the circular wave guide shown in Fig. 3. There is, however, one important difference. The tube-like arrangement down which the wave travels is actually a helix rather than a solid metallic cylinder. This means that the charge flowing in the walls cannot move from left to right in a straight line as it does in a wave guide but must travel around the helix in order to move down the length of the tube. This greatly reduces the propagation velocity and makes it conveniently possible to project an electron beam down the axis of the tube with a superior velocity. The situation is very similar to that of a circular wave guide in other respects, and in fact the formulas of circular wave guides need only to be specialized to require circular currents in order to furnish criteria for design of the helix.

**25¢ WILL GET YOU  
 2 TRIAL CANS  
 Rubyfluid**

**Paste & Liquid Soldering Flux**

Prove to yourself that Rubyfluid fluxes are the best for soldering any type of electrical connections—that they are easy and economical to use—have no harmful or objectionable fumes—wet out freely.

Send 25c in Coin or Stamps today for 2 trial cans.



**THE RUBY  
 CHEMICAL CO.**  
 61 McDowell St.  
 Columbus 8, Ohio

**Rubyfluid**

**REX  
 RHEOSTATS**

**REX RHEOSTAT COMPANY, BALDWIN, L. I., N. Y.**  
 RHEOSTATS & RESISTORS  
 Prompt Deliveries

In the Rocky Mountain Region it's  
**Radio & Television Supply Co.**  
 252 HOBSON AVENUE, PUEBLO, COLO.  
 P. O. Box #892  
 "If we don't have it, we'll get it—  
 or it can't be had! Phone 3729"

Only **FEDERAL** gives you  
2 plus values in . . .

## FM and TELEVISION LEAD-IN WIRE!

1. Produced by world's largest manufacturer of high frequency cable!
2. Engineered in the same laboratories that have put Federal in the forefront in FM and Television research!



**F**EDERAL's high frequency cable is *really engineered* for low-loss signal transmission from antenna to receiver . . . the product of years of experience in FM and Television.

It's a solid, polyethelene insulated type . . . resisting water, acids, alkalies, oils . . . won't embrittle or age in sunlight. It retains flexibility in sub-zero temperatures; and dimensional precision even in hot weather. Elliptical cross section enables it to withstand twisting and abrasion—eliminates any moisture conduction path.

Federal's lead-in cable is available to you now, in various sizes. Write for complete details.

*Federal lead-ins have dual, stranded conductors. Characteristic impedance for commercial telecasts is 300 ohms—capacity per foot is 5 mmf.*

*Other types produced for special applications and experimental work have characteristic impedances of 200 and 100 ohms.*

300 ohm  
line

200 ohm  
line

100 ohm  
line

# Federal Telephone and Radio Corporation

Export Distributor:  
International Standard Electric Corporation

Newark 1, New Jersey





# SYLVANIA NEWS

CIRCUIT ENGINEERING EDITION

AUG. Prepared by SYLVANIA ELECTRIC PRODUCTS INC., Emporium, Pa. 1946

## MODERN SET DESIGN SEEN GREATLY INFLUENCED BY NEW SYLVANIA ELECTRIC T-3 TUBE

*Commercial Version of Proximity Fuze Tube  
Is Tiny, Rugged, Has Long Life*

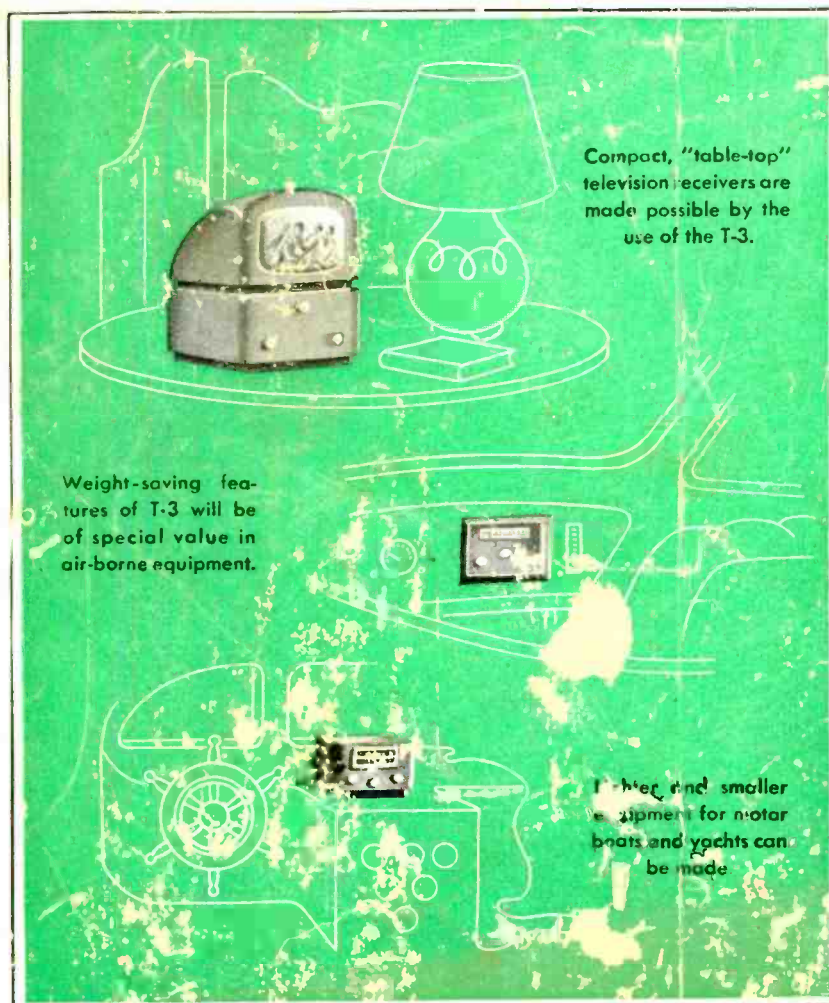

Radio equipment manufacturers are viewing with marked interest the radical reductions in size and weight now made possible in many types of electronic equipment through the use of the sensationally small Sylvania vacuum tube, T-3.

The commercial version of the former proximity fuze transceiver tube is noted for exceptional ruggedness... long life... ideal suitability for high frequency operation.

Some of the design possibilities opened by the T-3 are shown here. Of course, its potentialities are not limited to these fields.

Write Sylvania Electric Products Inc., Emporium, Pa.

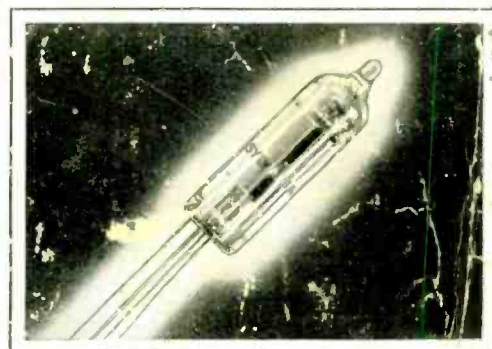

The T-3 tube is shown here in its actual size.

# SYLVANIA ELECTRIC

Emporium, Pa.

MAKERS OF RADIO TUBES; CATHODE RAY TUBES; ELECTRONIC DEVICES; FLUORESCENT LAMPS, FIXTURES, WIRING DEVICES; ELECTRIC LIGHT BULBS



... to get more for your money

Re-Tube with

# AMPEREX

replacements  
for your rectifier ...  
regardless of make!

## AMPEREX TUBES



575-A



315-A



321-A



255-B



857-B



266-B

- ★ are **DESIGNED** by ELECTRONIC TUBE Specialists ... in a laboratory that is second to none in the world—and with a background of experience that encompasses the entire history of electronic development.
- ★ are **BUILT BETTER** ... and while most makes may look alike, there are hundreds of little structural design differences in AMPEREX tubes that combine to make a **BIG** difference in stability and resistance to shock or vibration.
- ★ are **LONGER LASTING** ... because of close electrical tolerances, conservative ratings, rigid mechanical requirements, careful construction, plus painstaking inspection and test ... to assure the maximum number of operating hours within our specified ratings.
- ★ are **LOWER** in **COST** ... lower in initial cost—lower in cost per operating hour—As thousands of others already have done, try AMPEREX—prove it yourself, in your equipment.
- ★ are **AVAILABLE** for **IMMEDIATE DELIVERY** ... by leading radio parts distributors, who have AMPEREX tubes *IN STOCK*. We list a few of these establishments that are prepared to serve you instantly:

ALLIED RADIO CORP., 833 West Jackson Blvd., Chicago 7, Illinois  
 W. D. BRILL & CO., 198 10th Street, Oakland, California  
 DE MAMBRO RADIO SUPPLY INC., 1111 Commonwealth Avenue, Boston 15, Massachusetts  
 CRABTREE'S WHOLESALE RADIO, 2608 Ross Avenue, Dallas 1, Texas  
 A. W. MAYER CO., 895 Boylston Street, Boston 15, Massachusetts  
 RADIO & ELECTRONICS PARTS CORP., 3235 Prospect Avenue, Cleveland 15, Ohio  
 SOUTHEAST AUDIO CO., 112 West Union Street, Jacksonville, Florida

There are approximately 200 standard types in the complete line of

### AMPEREX TUBES

Rectifying, Transmitting, Industrial, Radiation Counter, Electro-Medical ... there's an AMPEREX tube for almost any electronic application. Have you our latest catalog? If not, write for it.

## RE-TUBE WITH AMPEREX AMPEREX ELECTRONIC CORP.

25 WASHINGTON STREET, BROOKLYN 1, N. Y.

In Canada and Newfoundland:

Canadian Radio Manufacturing Corp. Ltd.

11-19 Brentcliffe Road, Leaside, Toronto, Ontario, Canada





# Team Mates...



## ... for mobile communications

HERE ARE TWO unbeatable VHF power tube combinations for mobile transmitter designs where high efficiency and extreme compactness are paramount requirements. All four of these RCA-developed tubes have high power gain and may therefore be operated at relatively low plate voltage to provide large power output with small driving power.

The RCA-5763 miniature type beam power tube is very suitable as an output stage of low-power mobile transmitters and as a doubler or tripler in higher-power units. It can be operated with full input up to 175 Mc. The RCA-2E26 is intended primarily for use in the driver stages or the output stage of emergency mobile or FM transmitters. It can be operated with full input up to 125 Mc. and will provide an output of about 13 watts at 160 Mc.

The RCA-5618 power pentode and the RCA-2E24 beam power tube are quick-heating types with low fila-

ment drain, and are particularly suitable for mobile and emergency-communications transmitters where the operating power supply must be kept small. Both types are designed for intermittent operation. The RCA-5618 is superior as a doubler or tripler; the RCA-2E24, as the final amplifier in low-power FM transmitters.

Already proved in thousands of installations, these RCA tubes can be depended upon for their quality, ruggedness, and superior performance.

RCA Application Engineers are ready to work with you in applying any of these or other RCA tube types to your specific designs. For further information write RCA, Commercial Engineering, Section H42R, Harrison, New Jersey.

RCA Laboratories, Princeton, N. J.

THE FOUNTAINHEAD OF  
MODERN TUBE DEVELOPMENT IS RCA



**RADIO CORPORATION of AMERICA**  
ELECTRON TUBES

HARRISON, N. J.